

Innovative Technology

POWERING TRANSACTIONS AND INTERACTIONS

SMART Coin System Range User Manual

Document Revision - v.1

Exported on 29/04/2026

Change History

Version	Date	Comment
1	03 Jan 2025	Initial Release

 Uncontrolled Document Once Exported.
Please visit the [Support Hub](#) for the latest Information.

Table of Contents

- SMART Coin System Range Product Information
- SMART Coin System Range Technical Data
- SMART Coin System Range Mechanical Installation
- SMART Coin System Range Software Installation and Configuration
- SMART Coin System Range Protocols and Interfacing
- SMART Coin System Range Service Guide
- SMART Coin System Range Product Compliance
- SMART Coin System Range Appendix
- SMART Coin System Range Disclaimer and Safety Information

SMART Coin System Range Product Information

Contents

- SMART Coin System
 - General Description
 - Key Features
 - Typical Applications
 - Component Overview
 - SMART Coin System with Coin Elevator
 - General Description
 - Key Features
 - Typical Applications
 - Component Overview
 - Twin SMART Coin System
 - General Description
 - Key Features
 - Typical Applications
 - Component Overview
 - SMART Hopper
 - General Description
 - Key Features
 - Typical Applications
 - Component Overview
 - Nozzle Options SMART Hopper
 - PM00488 - Top Pay Nozzle (standard)
 - PM01107 - Combined Nose
 - PM02619 - TWIN SMART Coin System Primary Hopper Y-Nose
 - PM02618 - TWIN SMART Coin System Secondary Hopper Y-Nose
 - Pay In Chute Options SMART Coin System Range
 - PM01106 - Funnel (standard)
 - PA04138 - Chute with Debris Collection
 - Lid Options SMART Hopper
 - PA02051 - Lid Assembly (standard)
 - PA04140 - Hopper Locking Lid
 - PA02698 - Twin SMART Coin System Secondary Hopper Lid Assembly (standard for Twin SMART Coin System)
 - SD card slot
-

SMART Coin System

General Description

The SMART Coin System is a state-of-the-art bulk coin validator, mixed coin hopper and recycler in one. The unit validates, discriminates and stores mixed coins, eliminating coin starvation & the need for multiple hoppers. With a market leading coin hopper capacity and fully audited, efficient refills the SMART Coin System is designed to eliminate coin starvation and significantly reduce operator collection costs. Operating at a market leading 12 coins per second the SMART Coin System improves operator cashflow, significantly reducing collection costs.

Key Features

- State of the art bulk coin validator, hopper & recycler
- Eliminates coin starvation
- Market leading coin capacity, acceptance and payout speed
- Lowest cost of ownership
- High security - multi frequency sensing technology

Typical Applications

- Gaming
- Retail & Kiosk

Component Overview



Validation process explanation: The device **first mechanically singulates the coins**, ensuring that each coin is processed individually. It then uses a combination of **diameter sensors, inner and outer material sensors**, and an **acoustic sensor** to take precise readings from each coin.

The data collected by these sensors is **combined and processed through in-house developed algorithms**, which determine whether the coin is included in the valid dataset or not.

Note: The system **does not classify coins into three categories** (genuine, counterfeit, and unknown). Instead, coins are categorized only as **recognized (real)** or **unrecognized (unknown)**.

SMART Coin System with Coin Elevator

General Description

The Coin Elevator is an add-on module designed to work seamlessly with both the SMART Coin System. It significantly reduces the distance between the coin entry and payout points, improving accessibility and enhancing the overall customer payment experience.

By repositioning coin input/output to a more ergonomic height, the Coin Elevator helps operators comply with ADA and DDA accessibility guidelines, making self-service solutions more inclusive. The closed-loop system ensures secure coin handling with full audit traceability and zero shrinkage.

Key Features

- Minimises distance between coin entry and exit – improved customer experience
- Ergonomic design – supports compliance with ADA & DDA accessibility standards
- Compatible with SMART Coin System
- Closed-loop operation – secure and fully auditable
- Ideal for customer-facing environments requiring inclusive design

Typical Applications

- Gaming
- Retail & Kiosk

Component Overview

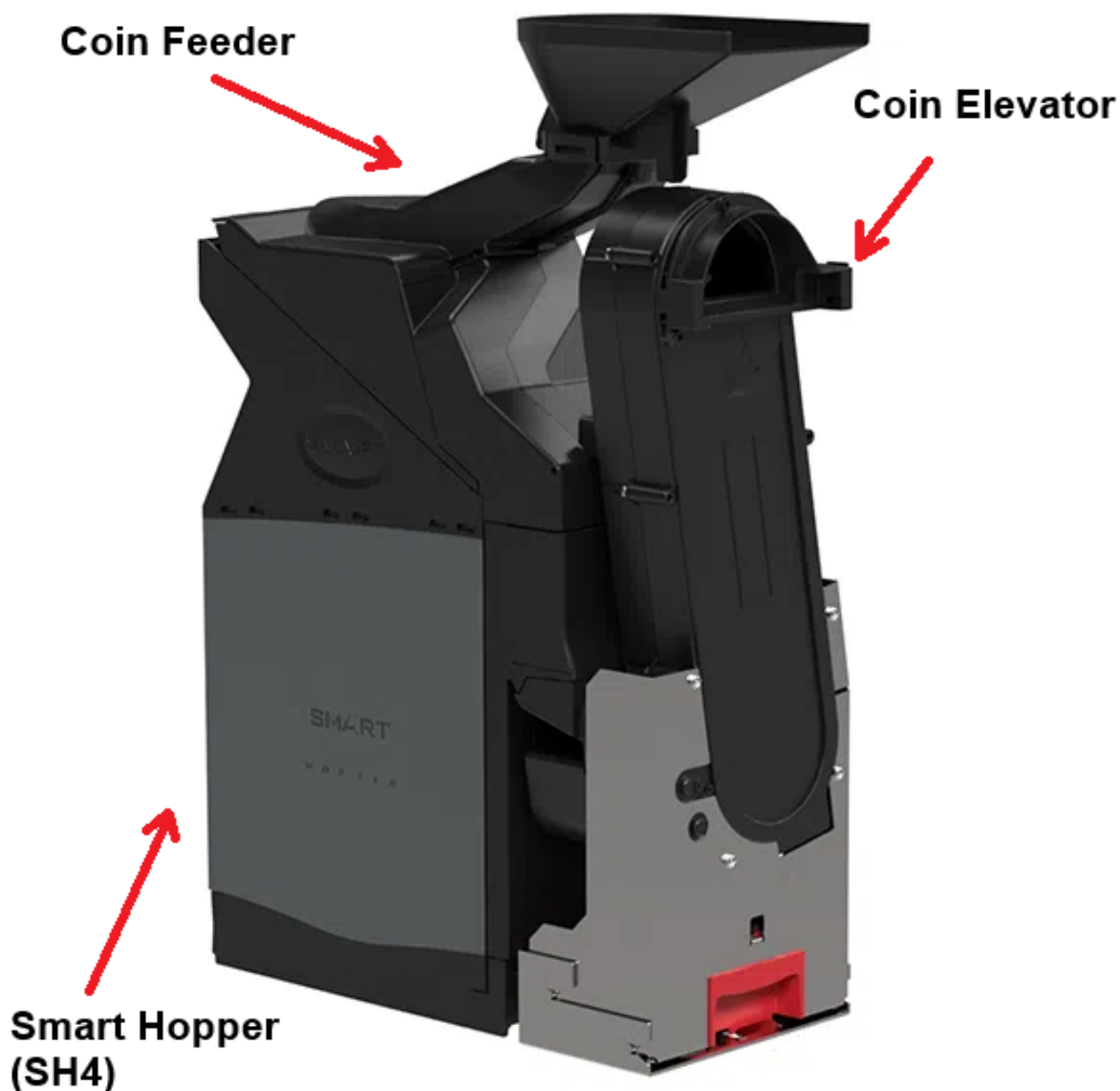

Twin SMART Coin System

General Description

The Twin SMART Coin System is a state-of-the-art bulk coin validator, with two mixed coin hoppers and two recyclers in one. The unit validates, discriminates and stores mixed coins, eliminating coin starvation & the need for multiple hoppers. With a market leading coin hopper capacity and fully audited, efficient refills the Twin SMART Coin System is designed to eliminate coin starvation and significantly reduce operator collection costs. Operating (Payout) at a market leading up to 24 coins per second the Twin SMART Coin System improves operator cashflow, significantly reducing collection costs.

Key Features

- Combined bulk coin validator, 2x mixed coin hoppers & recyclers
- Eliminates coin starvation
- Market leading coin capacity, acceptance and payout speed
- Lowest cost of ownership
- High security - multi frequency sensing technology

Typical Applications

- Gaming
- Retail & Kiosk

Component Overview

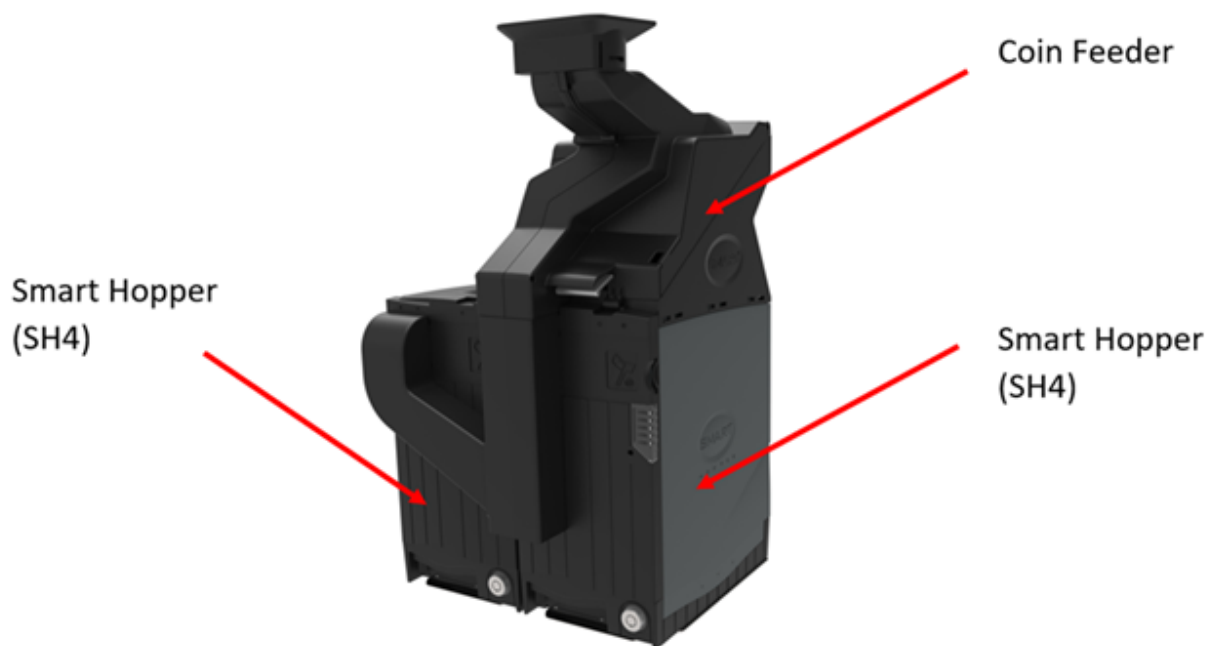

SMART Hopper

General Description

The SMART Hopper from Innovative Technology is a state of the art multi-coin hopper and recycler that eliminates coin starvation. Boasting a market leading mixed coin capacity, the SMART Hopper removes the need for multiple hoppers, maximising cash efficiency. The SMART Hopper reduces the cost of handling coins internally, eliminating

the need for multiple hoppers & sorters. Operating at an industry leading 12 coins per second the SMART Hopper is a true multi-coin pay-out unit capable of accepting all coins passed through the coin mechanism.

Key Features

- State of the art multi coin hopper & recycler
- Technologically advanced
- Lowest cost of ownership
- High security

Typical Applications

- Gaming
- Retail & Kiosk

Component Overview



Nozzle Options SMART Hopper

For the SMART Hopper two different Nozzle options are available based on the host machine requirements:

PM00488 - Top Pay Nozzle (standard)

- Usually in use for SMART Hopper 3 replacement

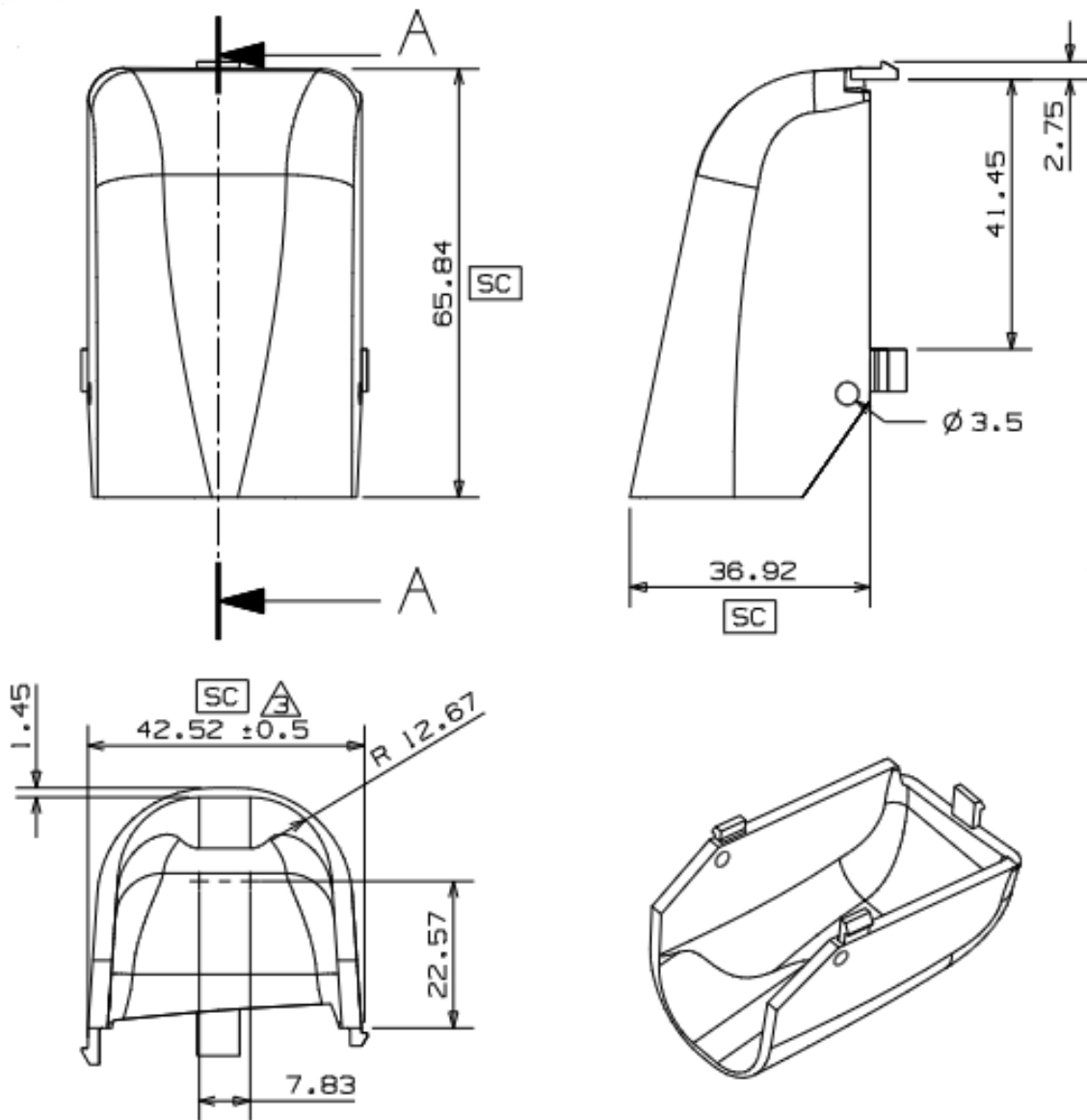

PM01107 - Combined Nose

- mandatory for usage with the Coin Feeder

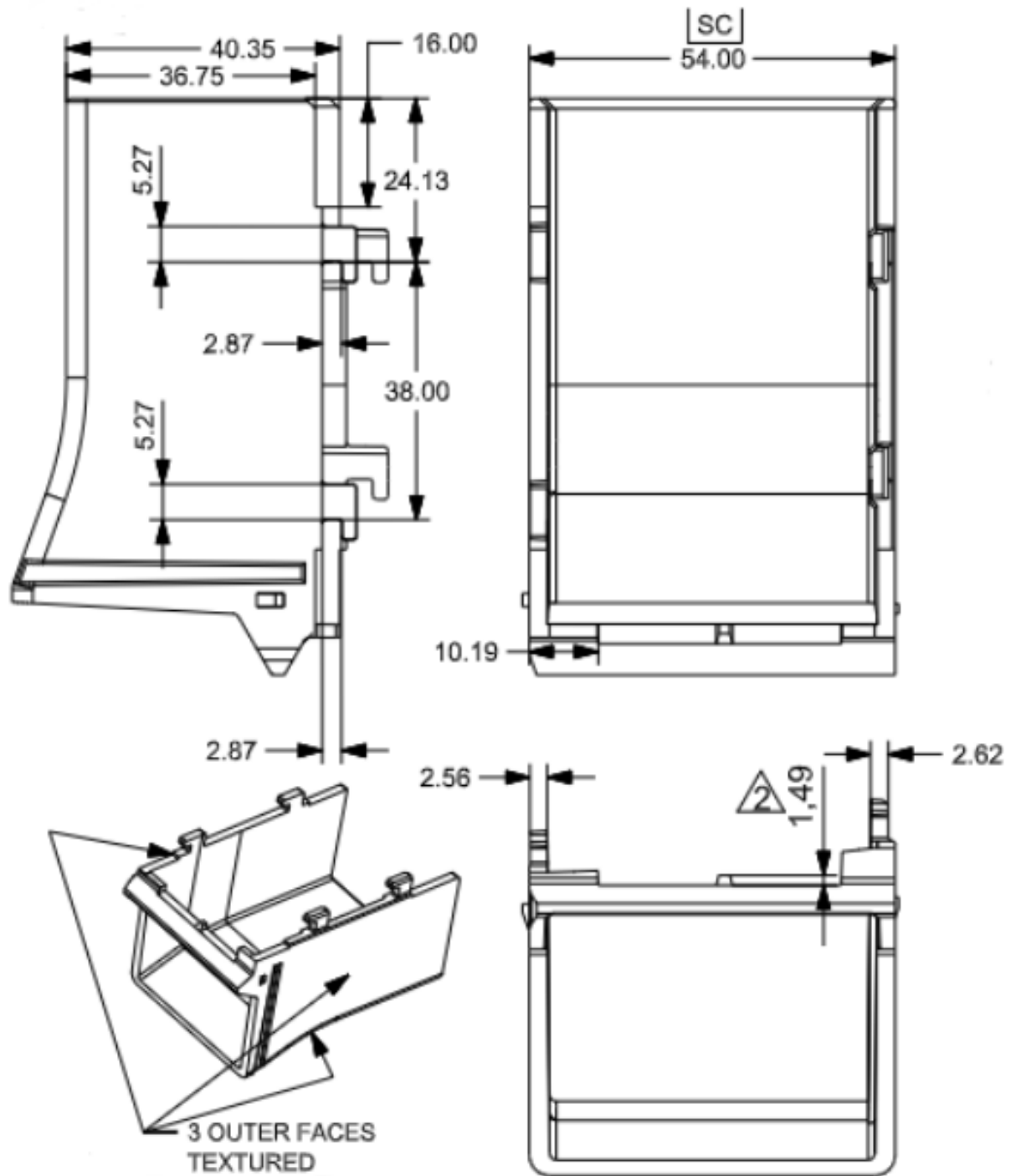

PM02619 - TWIN SMART Coin System Primary Hopper Y-Nose

- Standard on Primary Hopper side of the TWIN SMART Coin System

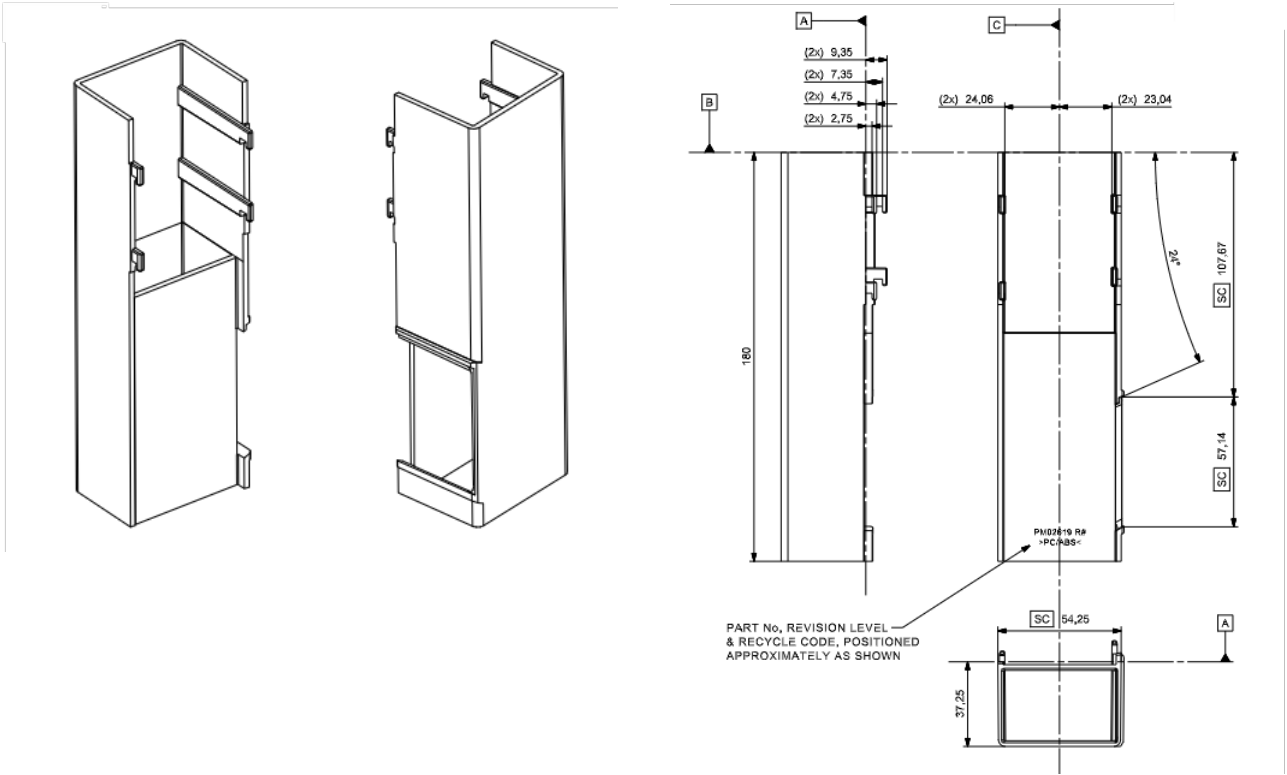

PM02618 - TWIN SMART Coin System Secondary Hopper Y-Nose

- Standard on Secondary Hopper side of the TWIN SMART Coin System

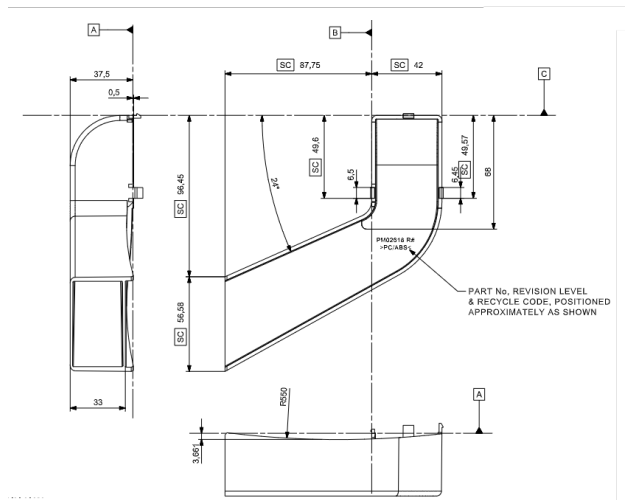
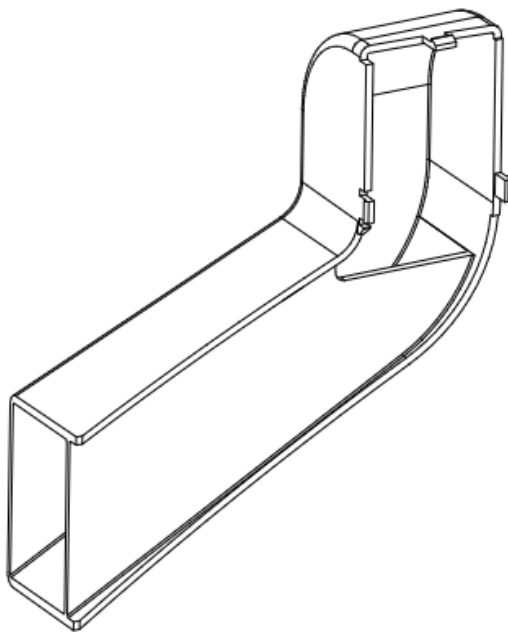

Pay In Chute Options SMART Coin System Range

For the SMART Coin System and Twin SMART Coin System two different Pay In Chute options are available based on the host machine requirements:

PM01106 - Funnel (standard)

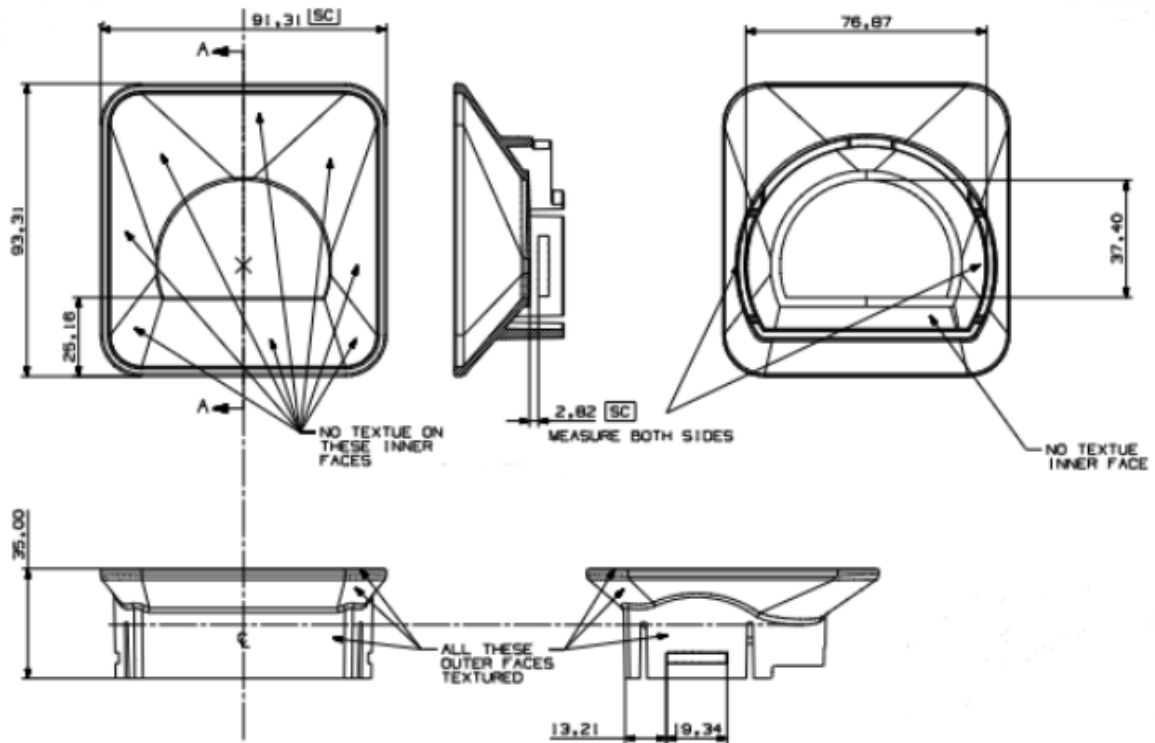

PA04138 - Chute with Debris Collection

- Required for Coin Elevator integrations and strongly recommended for new integrations for SMART Coin System or Twin SMART Coin System.

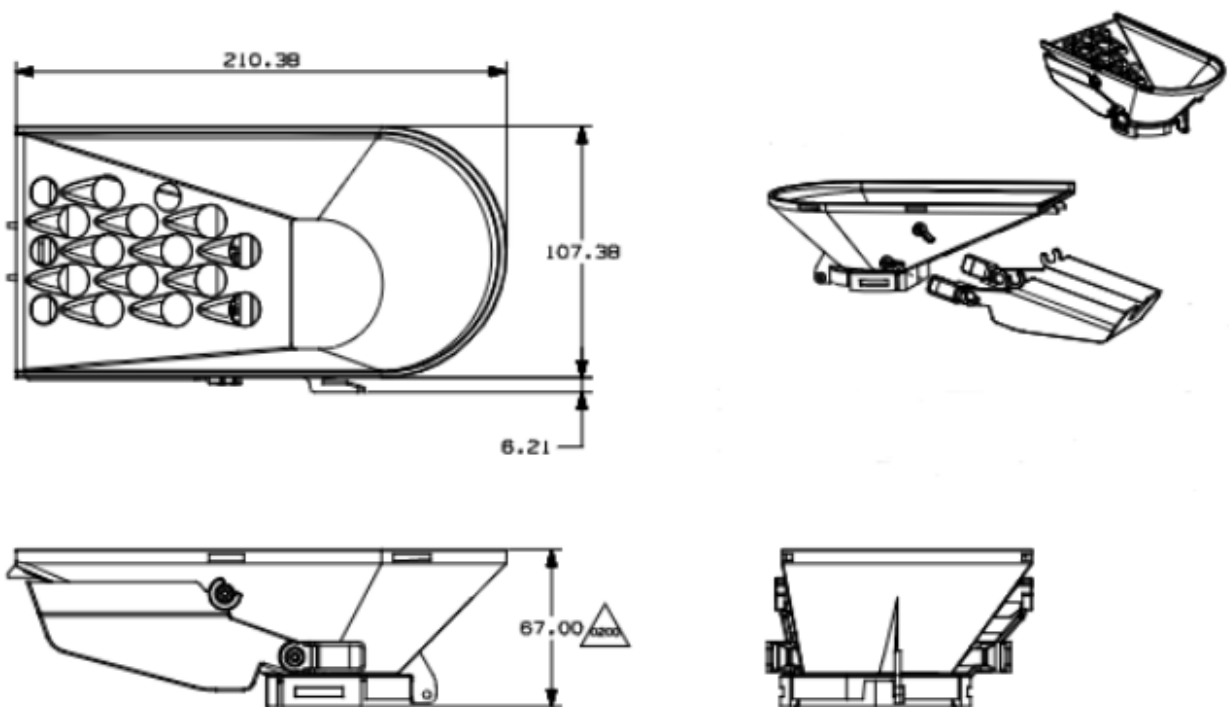

Lid Options SMART Hopper

For the SMART Hopper two different Lid Chute options are available based on the requirements:

PA02051 - Lid Assembly (standard)

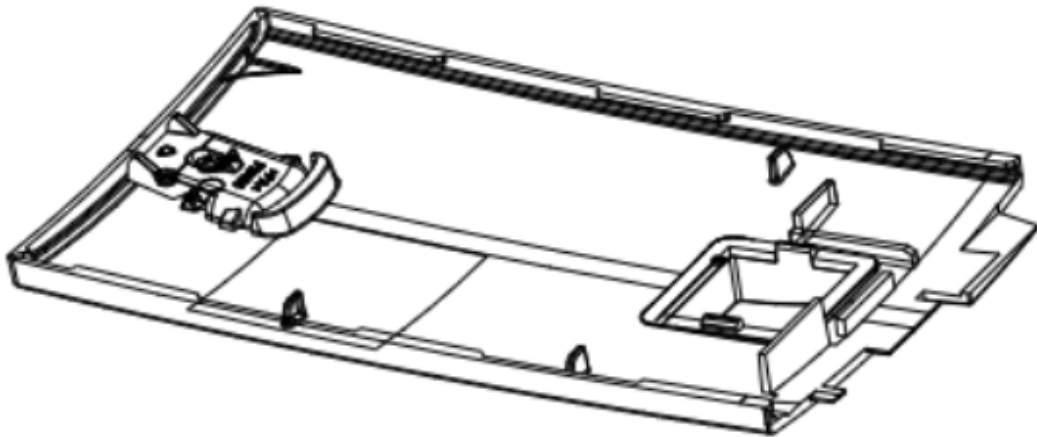

PA04140 - Hopper Locking Lid

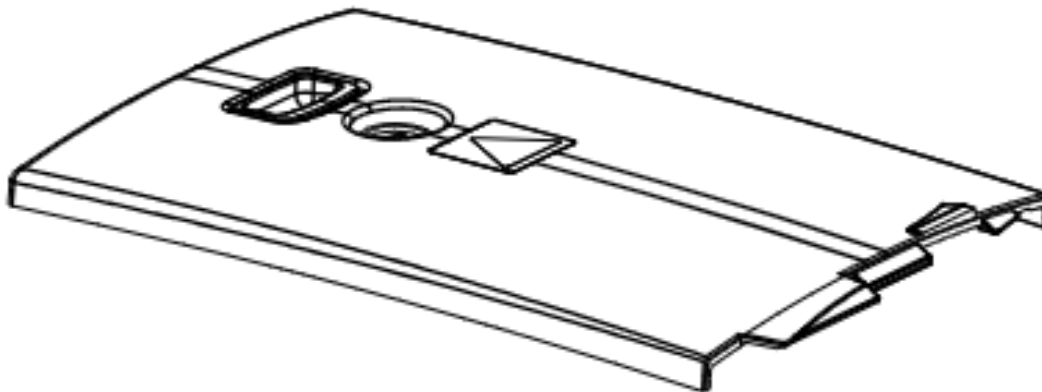

- Possibility to prevent the Hopper Lid to be removed without Key. The required lock specification can be found at [Lock Specifications](#) and the required lock cam part numbers at [Lock Cam](#).

PA02698 - Twin SMART Coin System Secondary Hopper Lid Assembly (standard for Twin SMART Coin System)

- Only available for the Twin SMART Coin System Secondary Hopper (not for the SMART Hopper)

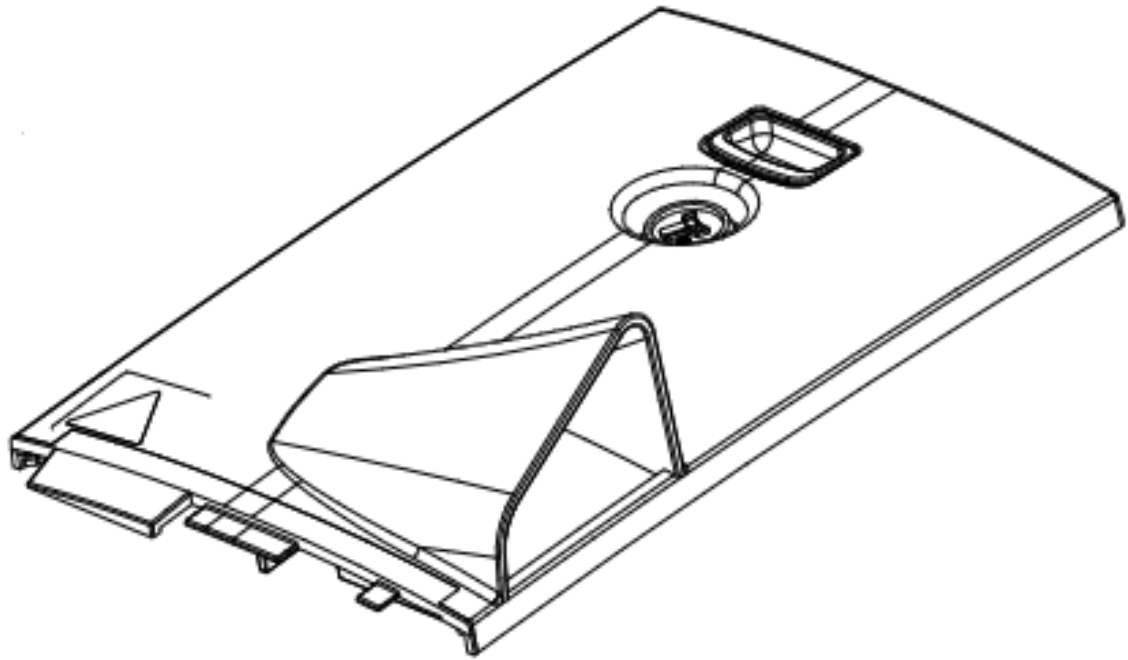

SD card slot

The card slot can be found on the exterior side of the hopper assembly.

Requirements	Partition style	Format	Capacity	Speed class
Minimum	MBR	FAT32	4 GB	4
Maximum			32 GB *	10

* A larger capacity should not be an issue provided the card is formatted as FAT32/MBR.

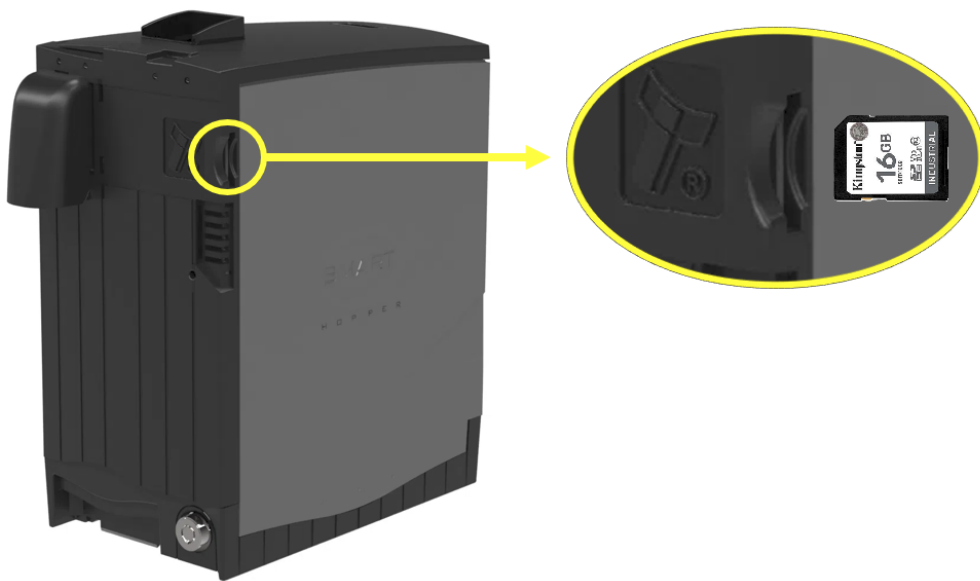

Recommendation

Description	Manufacturer reference
SanDisk Ultra 32GB SDHC	SDSDUN4-032G-GN6IN
SD Card 16GB HC – Speed class 10 UHS-1	IC02017 (ITL reference)

SMART Coin System Range Technical Data

Contents

- Dimensions
 - SMART Coin System
 - Twin SMART Coin System
 - SMART Hopper
 - Coin Elevator
 - Weights
 - Environmental Requirements
 - Operation
 - Storage
 - Power Requirements
 - SMART Coin System
 - Twin SMART Coin System
 - SMART Hopper
 - Interface Logic Levels
 - Reliability Data
 - Media Requirements
-

Dimensions

SMART Coin System

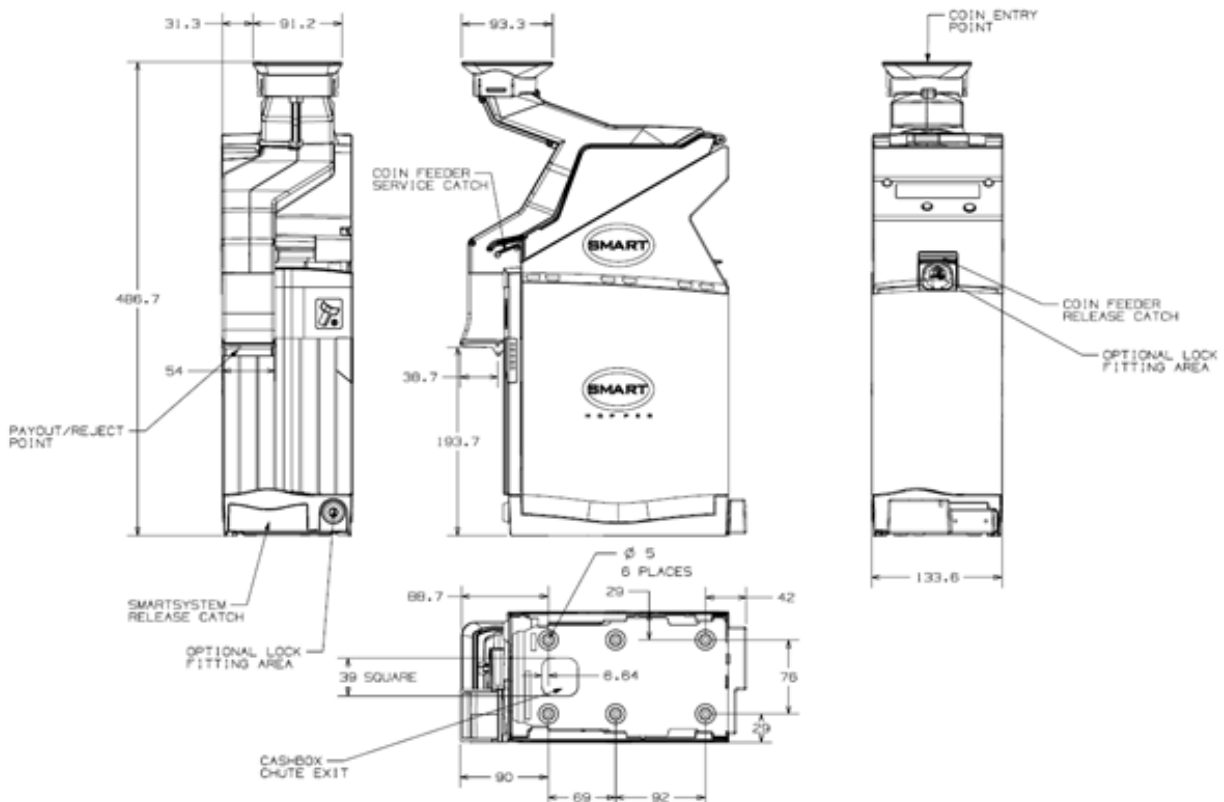

Twin SMART Coin System

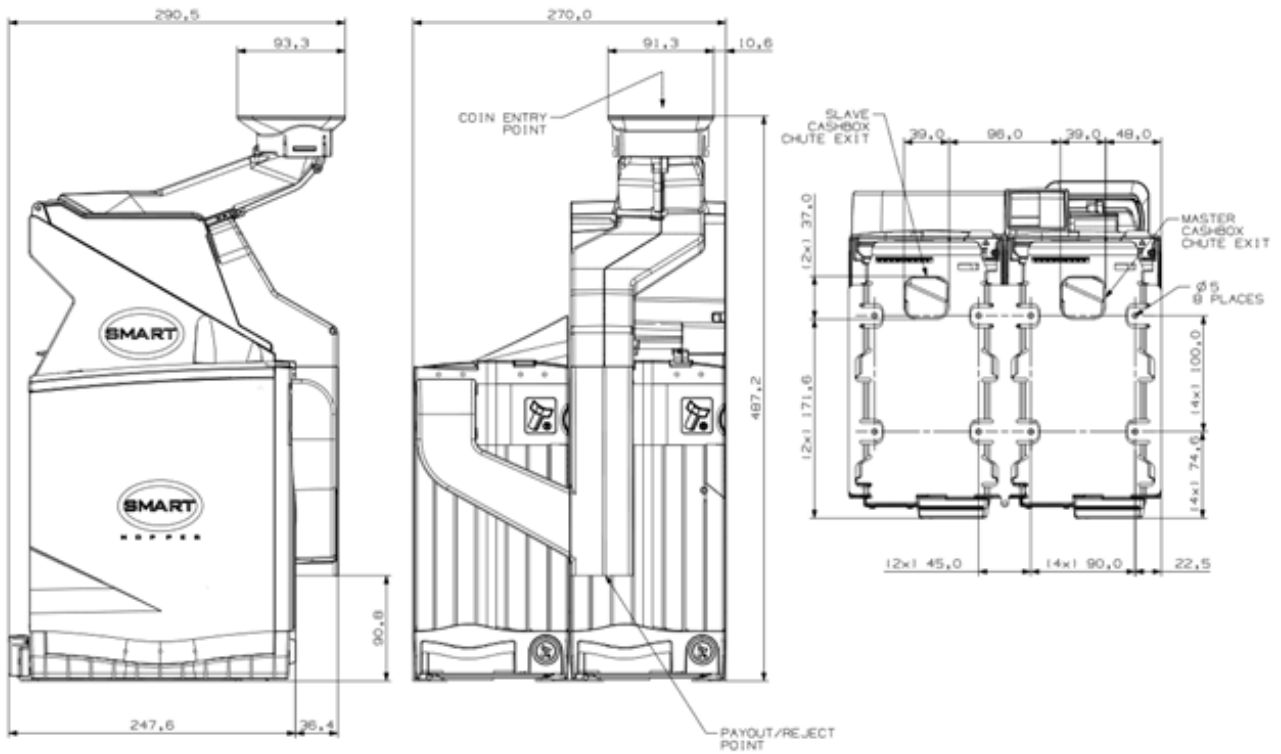

SMART Hopper

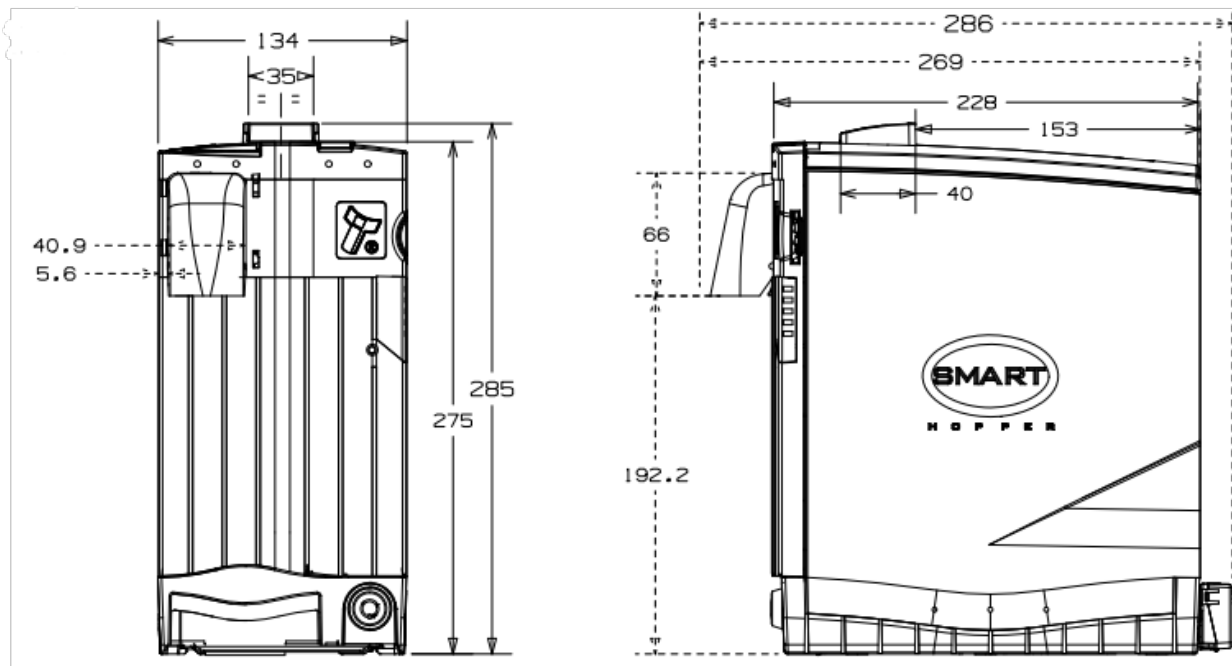

Coin Elevator

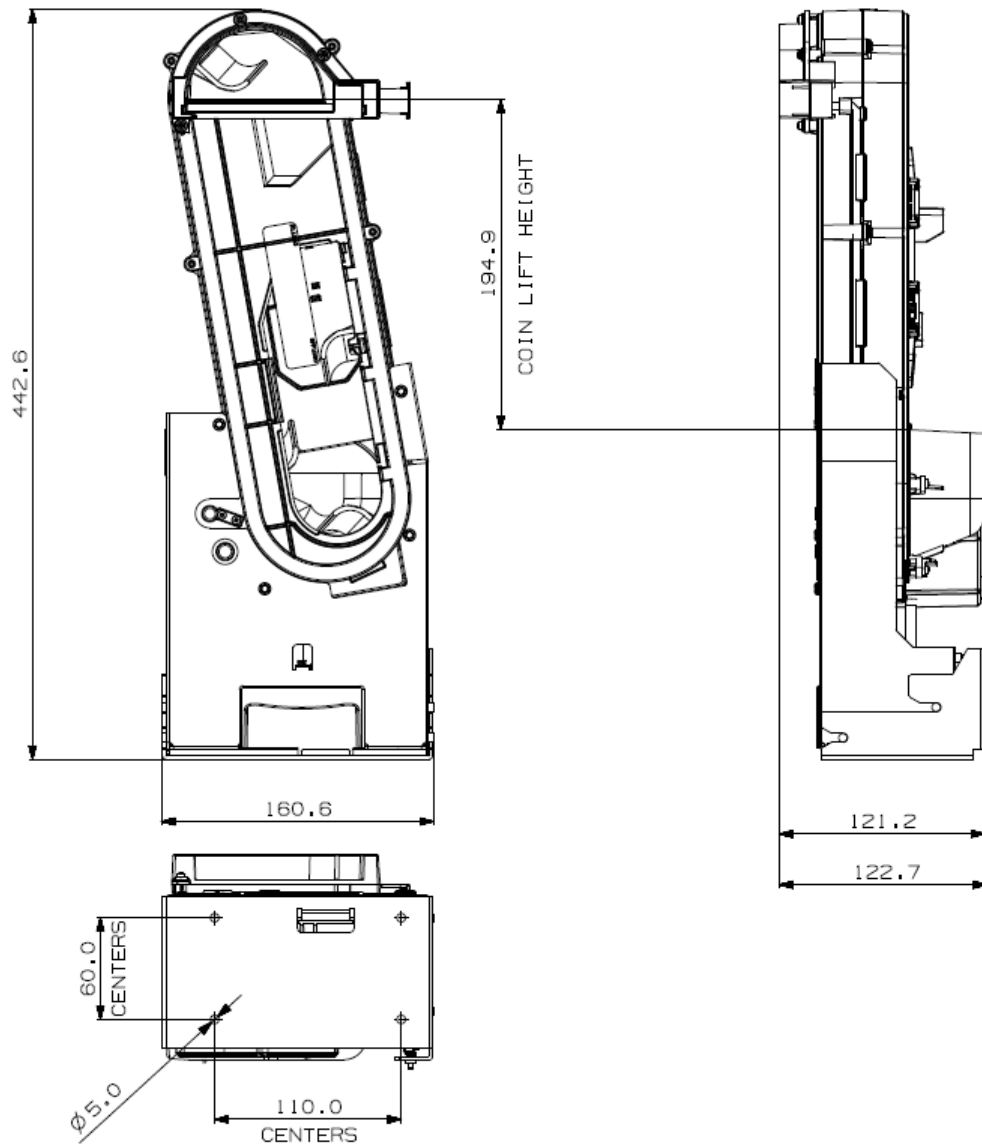

Weights

- SMART Coin System Empty: 4kg
- SMART Coin System Full: 18kg (approx.)
- TWIN SMART Coin System Empty: 6.5kg
- TWIN SMART Coin System Full: 31kg (approx.)
- SMART Hopper Empty: 2.4kg
- SMART Hopper Full: 13.7kg (approx.)
- Coin Elevator: 1.33kg (approx)

Environmental Requirements

Operation

Environment	Minimum	Maximum
Temperature	+3°C	+50°C
Humidity	5%	95% Non-condensing

Storage

Environment	Minimum	Maximum
Temperature	+0°C	+70°C
Humidity	5%	95% Non-condensing

Power Requirements

SMART Coin System

Supply Voltage

Supply Voltage	Minimum	Nominal	Maximum
Supply Voltage (V DC)	+ 21.6 V DC	+ 24 V DC	+ 26.4 V DC
Supply Ripple Voltage	0 V	0 V	0.25 V @ 100 Hz

Supply Currents

Supply Current	Minimum	Nominal	Maximum
Standby	0.4 A	0.4 A	0.7 A
Running	0.4 A	3 A	6.5 A
Peak	0.4 A	3 A	6.5 A

Power Supply Guidance

The SMART Coin System requires a stable 24 V DC / 6.5 A power supply. Please check the power requirements of your host machine and other peripherals to dimension a suitable power environment for your machine setup.

TDK Lambda manufactures suitable power supplies. Please see table below for further details.

Power Supply Unit	Specification	RS Stock Code	Farnell Stock Code
TDK Lambda LS200-24	24V/8.4A	739-7979	1995941



Lack of proper earth bonding causes failures!

It is very important that the SMART Coin System is properly bonded to earth. Lack of proper bonding can cause communication issues and other failures.

Twin SMART Coin System

Supply Voltage

Supply Voltage	Minimum	Nominal	Maximum
Supply Voltage (V DC)	+ 21.6 V DC	+ 24 V DC	+ 26.4 V DC
Supply Ripple Voltage	0 V	0 V	0.25 V @ 100 Hz

Supply Currents

Supply Current	Minimum	Nominal	Maximum
Standby	0.3 A	0.3 A	0.3 A
Running	0.3 A	4 A	11.2 A
Peak	0.3 A	4 A	11.2 A

Power Supply Guidance

The Twin SMART Coin System requires a stable 24 V DC / 11.2 A power supply for every device (Secondary and Primary). Please check the power requirements of your host machine and other peripherals to dimension a suitable power environment for your machine setup.

TDK Lambda manufactures suitable power supplies. Please see table below for further details.

Power Supply Unit	Specification	RS Stock Code	Farnell Stock Code
TDK Lambda RWS300B-24	24V/12.5A	813-9128	2444007



Lack of proper earth bonding causes failures!

It is very important that the Twin SMART Coin System is properly bonded to earth. Lack of proper bonding can cause communication issues and other failures.

SMART Hopper

Supply Voltage

Supply Voltage	Minimum	Nominal	Maximum
Supply Voltage (V DC)	+ 21.6 V DC	+ 24 V DC	+ 26.4 V DC
Supply Ripple Voltage	0 V	0 V	0.25 V @ 100 Hz

Supply Currents

Supply Current	Minimum	Nominal	Maximum
Standby	0.2 A	0.4 A	0.7 A
Running	0.2 A	3 A	6.5 A
Peak	0.2 A	3 A	6.5 A

Power Supply Guidance

The SMART Hopper requires a stable 24 V DC / 6.5 A power supply. Please check the power requirements of your host machine and other peripherals to dimension a suitable power environment for your machine setup.

TDK Lambda manufactures suitable power supplies. Please see table below for further details.

Power Supply Unit	Specification	RS Stock Code	Farnell Stock Code
TDK Lambda LS200-24	24V/8.4A	739-7979	1995941



Lack of proper earth bonding causes failures!

It is very important that the SMART Hopper is properly bonded to earth. Lack of proper bonding can cause communication issues and other failures.

Interface Logic Levels

Interface Logic Levels	Logic Low	Logic High
Inputs	0V to +0.5V	3.7V min = High internal pullup
Outputs with 2K2Ω pull-up resistor	+0.6V	Pull-up voltage of host interface
Maximum Current Sink	50mA per Output	

Reliability Data

Below is an explanation outlining the Mean Cycles Between Failure (MCBF) & Mean Cycles Between Interruption (MCBI) for the SMART Coin System. Where a cycle is defined as a coin either accepted or paid-out. An example is if a 2€ coin is accepted and a 1€ coin paid out that would be classed as 2 cycles.

The difference between MCBF and MCBI is that a failure is classed as an event which will require a service call – e.g. unit is seeing poor acceptance. Whereas an interruption is an event which store/site staff could rectify without a trained engineer present – e.g. clearing a coin jam.

- MCBF: 100,000
- MCBI: available on request

Lifetime is the number of cycles a unit is expected to perform before the cost of repair exceeds cost of unit replacement.

- Lifetime: available on request

Please contact support@innovative-technology.com for further information. Detailed information is available on request.

Media Requirements

Coin	Min	Max
Diameter	18mm	28.5mm
Thickness	1.65mm	3.2mm

Depending on the Currency a different SMART Coin System or TWIN SMART Coin System Hardware Type is required. Please contact support@innovative-technology.com for further information. Detailed information is available on request.

SMART Coin System Range Mechanical Installation

Contents

- [Compatibility](#)
 - [SMART Coin System](#)
 - [Twin SMART Coin System](#)
 - [Nozzle Mounting](#)
 - [Nozzle Removal](#)
 - [Nozzle Fitting](#)
 - [Coin Elevator Mounting](#)
 - [Baseplate Mounting](#)
 - [SMART Coin System](#)
 - [Twin SMART Coin System](#)
 - [Lock Mounting](#)
 - [Lock Fitting](#)
 - [Lock Removal](#)
 - [Lock Specifications](#)
 - [Lock Cam](#)
 - [Machine Mounting](#)
 - [SMART Coin System](#)
 - [Twin SMART Coin System](#)
 - [Earth Bonding](#)
 - [Additional Earth Bonding in Machine Housing](#)
 - [Additional Recommendations](#)
 - [Screw Specifications](#)
-

Compatibility

SMART Coin System

Hardware Compatibility

Machine Mounting

Assuming the suitable Base Plate is ordered within the SMART Coin System it can be used as fitting replacement for the SMART Hopper 3.

Innovative Technology Ltd. has a policy of continuous product improvement. Due to design changes, older model or product additions (Baseplate) may not be compatible with the SMART Coin System. However, new product deliveries always include a Baseplate that must be used.



Only use Baseplate delivered with the product!

Machine Interfacing

By design the SMART Coin System is pin to pin compatible with the suitable fitting replacement product listed above if you are using the suitable Base Plate for the SMART Coin System. No changes to existing machine harnessing are required.

Power Supply

It is vital that the SMART Coin System is connected to a power supply being able to provide the required power environment. A weak power supply causes malfunctioning of the SMART Coin System such like coin rejects or missing credits. If the SMART Coin System is used as a fitting replacement for an older model or product we recommend to check the power supply specifications of the machine. The power supply of the machine might be

designed for the older model or product but not suitable for the SMART Coin System. The SMART Coin System might have higher power consumption.

 A weak power supply may cause malfunction!

Software Compatibility

Interface Protocols

When using the SMART Coin System as a fitting replacement for an older model or product some events such like credits may be given earlier. This is due to improved firmware routines and faster motors being used. This may cause missing events such like credits in those host machines where timeouts are defined for the older model or product. Please contact the machine manufacturer for full compatibility of the SMART Coin System.

 Timing issues may cause missing events such as credits!

Re-programming

For re-programming the SMART Coin System always use the latest version of Validator Manager available for download on our website. Older versions may not support the SMART Coin System.

 Older versions of Validator Manager may not support the SMART Coin System!

Twin SMART Coin System

Hardware Compatibility

Machine Mounting

The Twin SMART Coin System can not be used as fitting replacement for the SMART Hopper or SMART Coin System and the machine housing would need a re-design.

 Only use Baseplate delivered with the product!

Machine Interfacing

By design the Twin SMART Coin System is not pin to pin compatible with the SMART Coin System or SMART Hopper. Changes to existing machine harnessing are required.

Power Supply

It is vital that the Twin SMART Coin System is connected to a power supply being able to provide the required power environment. A weak power supply causes malfunctioning of the Twin SMART Coin System such like coin rejects or missing credits. If the Twin SMART Coin System is used as a fitting replacement for an older model or product we recommend to check the power supply specifications of the machine. The power supply of the machine might be designed for the older model or product but not suitable for the Twin SMART Coin System. The Twin SMART Coin System might have higher power consumption.

 A weak power supply may cause malfunction!

Software Compatibility

Interface Protocols

When using the Twin SMART Coin System as a fitting replacement for an older model or product some events such like credits may be given earlier. This is due to improved firmware routines and faster motors being used. This may cause missing events such like credits in those host machines where timeouts are defined for the older model or product. Please contact the machine manufacturer for full compatibility of the Twin SMART Coin System.

 Timing issues may cause missing events such as credits!

Re-programming

For re-programming the Twin SMART Coin System always use the latest version of Validator Manager available for download on our website. Older versions may not support the Twin SMART Coin System.

 Older versions of Validator Manager may not support the Twin SMART Coin System!

Nozzle Mounting

Nozzle Removal

Pressing the Front Latch

Press the Latch on the Coin Feeder to open the Lid of the Coin Feeder.



Lift the Lid

Lift the Lid of the Coin Feeder back to the End Position.



Nozzle Removal

Move the Nozzle Up until it will release.



Nozzle Fitting

Pressing the Front Latch

Press the Latch on the Coin Feeder to open the Lid of the Coin Feeder.



Lift the Lid

Lift the Lid of the Coin Feeder back to the End Position.



Nozzle Fitting

Move the Nozzle Down until it will engage.



Coin Elevator Mounting

Coin Elevator Fitting

Position the Coin Elevator in front of the SMART Coin System, with the SCS coin exit aligned with the Coin Elevator tray. Connect the Coin Elevator cable (WR02270) to the SMART Coin System Baseplate (Coin Mech Port).



Baseplate Mounting

SMART Coin System

Baseplate Removal

Pressing the Latch

Press the Latch on the SMART Hopper to release the SMART Coin System from the Baseplate.

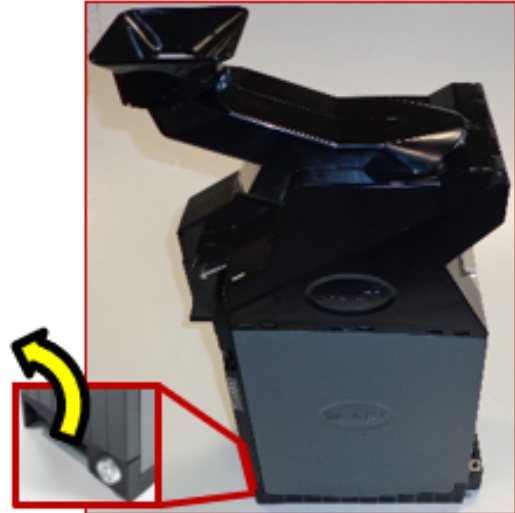

Baseplate Removal

Slide the SMART Coin System from the Plate.

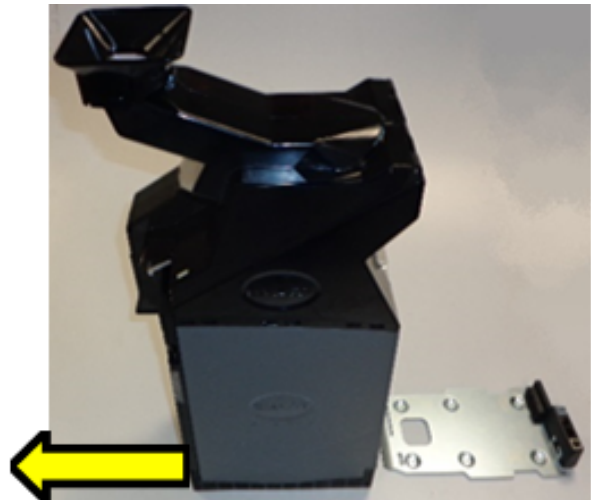

Baseplate Fitting

Baseplate Fitting

Slide the SMART Coin System on the Baseplate.

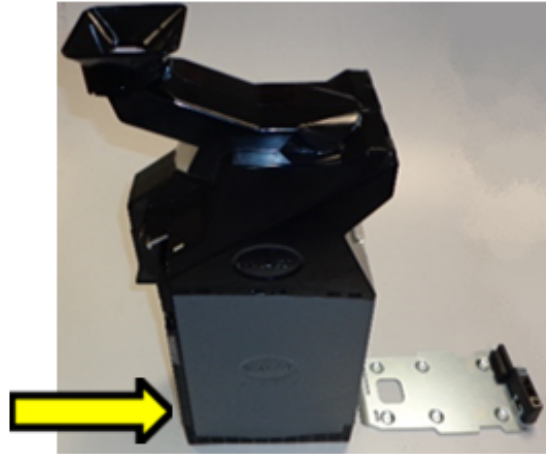

Twin SMART Coin System

Baseplate Removal

Baseplate Removal Primary

Press the Latch on the SMART Hopper to release the SMART Coin System from the Baseplate and slide the SMART Coin System from the Baseplate.



Baseplate Removal Secondary

Press the Latch on the SMART Hopper to release the SMART Hopper from the Baseplate and slide the SMART Hopper from the Baseplate.



Baseplate Fitting

Baseplate Fitting Secondary

Slide the SMART Hopper on the Baseplate.



Baseplate Fitting Primary

Slide the SMART Coin System on the Baseplate.



Lock Mounting

Lock Fitting

Coin Feeder

Pressing the Front Latch

Press the Latch on the Coin Feeder to open the Lid of the Coin Feeder.



Pressing the Rear Latch

Press the Rear latch on the Coin Feeder rear to Remove the Coin Feeder from the SMART Hopper.



Detachment of the Coin Feeder

Move the Coin Feeder to the SMART Hopper back. Now move the Coin Feeder up.



Removing the Coin Feeder Latch

Clip the Latch out of position with a flat screw driver.

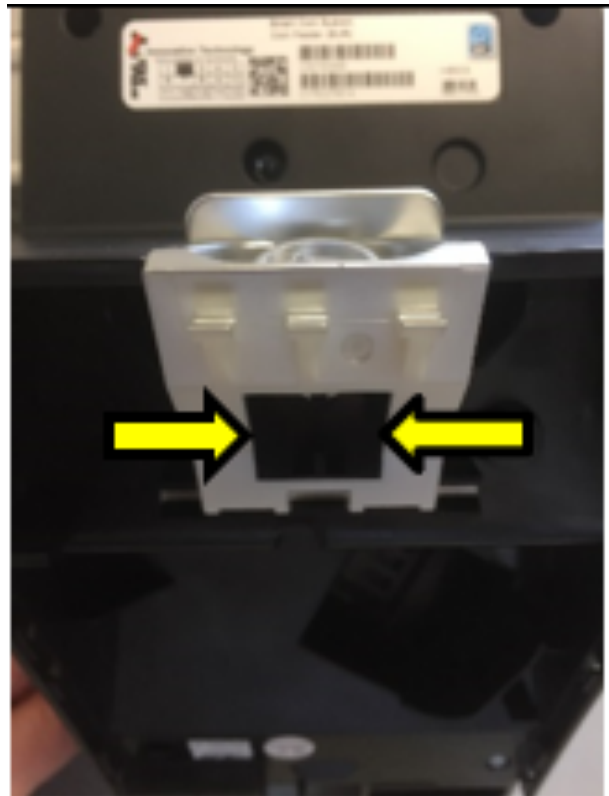

Removing Lock Blank Plug

Press the 2 clips on the Left and Right Side of the Plug and press the Plug out of the Latch.

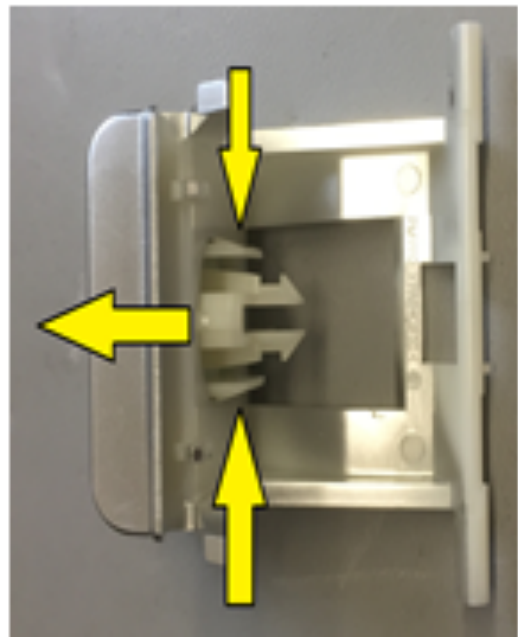

Inserting the Lock

Insert the Lock instead of the Plug.



Fixture of the Lock

Attach the nut on the Lock to fix the Lock on the Latch.



Lock Cam

Attach the Lock Cam on the Lock.



Fixture of the Lock Cam

Attach the Nut on the Lock to fix the Cam on the Lock.



Latch Attachment

Clip the Latch with the Lock back to its Position.



SMART Hopper

Baseplate Removal

Press the Latch on the SMART Hopper to release the SMART Coin System from the Baseplate and slide the SMART Coin System from the Baseplate.

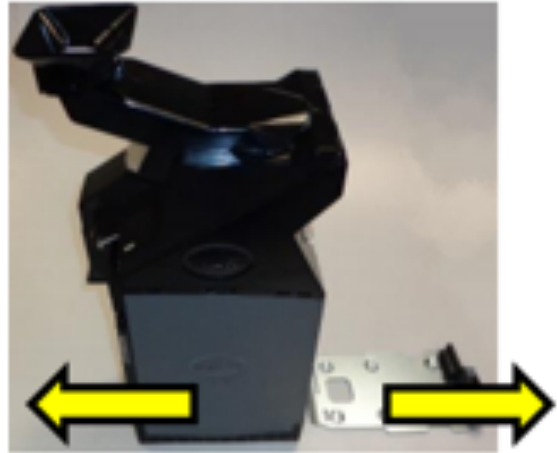

Pressing the Front Latch

Press the Rear latch on the Coin Feeder rear to Remove the Coin Feeder from the SMART Hopper.



Pressing the Rear Latch

Press the Rear latch on the Coin Feeder rear to Remove the Coin Feeder from the SMART Hopper.



Detachment of the Coin Feeder

Move the Coin Feeder to the SMART Hopper back. Now move the Coin Feeder up.



Rotate the SMART Hopper

Rotate the SMART Hopper to have the Bottom of the SMART Hopper Up.

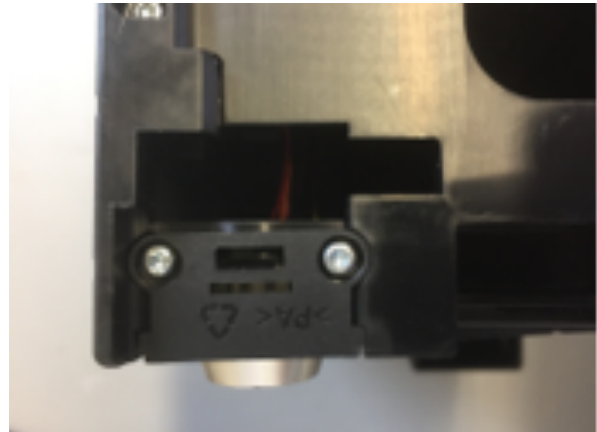

Screw Removal

Unscrew the 2 Screws which fix the Lock Bracket.

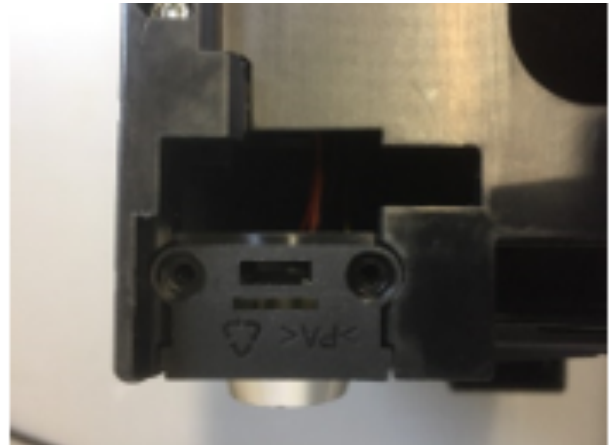

Lock Bracket Removal

Remove the Lock Bracket with an flat screwdriver.

**Plug Removal and insert the Lock**

Press the 2 clips on the Left and Right Side of the Plug and press the Plug out of the Bracket Insert the Lock instead of the Plug.

**Fixture of the Lock**

Attach the nut on the Lock to fix the Lock on the Bracket.

**Lock Cam**

Attach the Lock Cam on the Lock.



Fixture of the Lock Cam

Attach the Nut on the Lock to fix the Cam on the Lock.

**Bracket Assembly**

Insert the Bracket with the Lock back to its position.

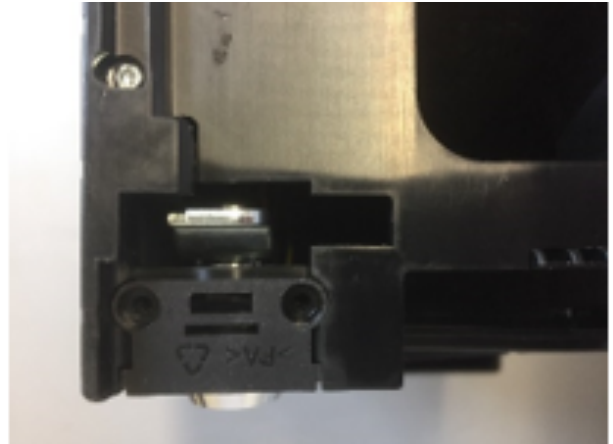
**Screw Onto**

Screw on the Bracket with the Lock.



Back to Operation

Rotate the SMART Hopper to its original Position, attach the Coin Feeder and slide the SMART Coin System on the Baseplate.



Lock Removal

Coin Feeder

Pressing the Front Latch

Press the Latch on the Coin Feeder to open the Lid of the Coin Feeder.



Pressing the Rear Latch

Press the Rear latch on the Coin Feeder rear to Remove the Coin Feeder from the SMART Hopper.



Detachment of the Coin Feeder

Move the Coin Feeder to the SMART Hopper back. Now move the Coin Feeder up.



Removing the Coin Feeder Latch

Clip the Latch out of position with a flat screw driver.

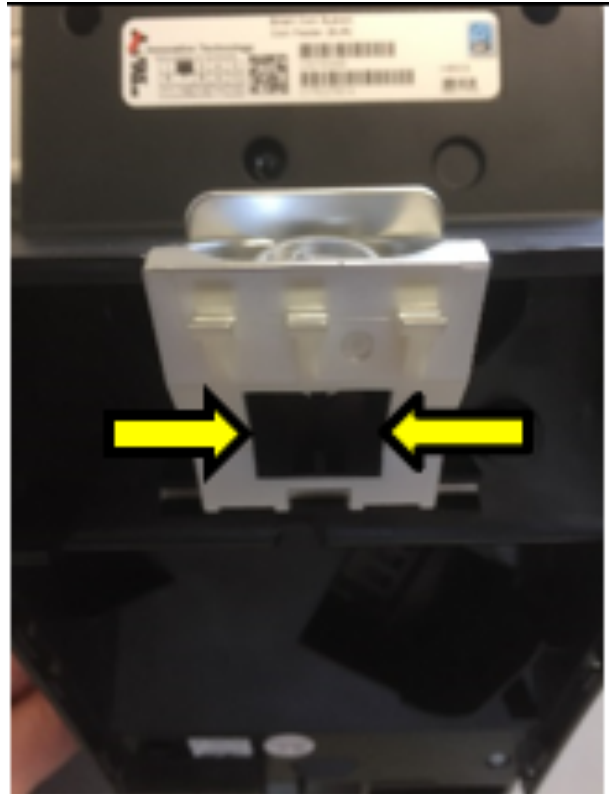

Nut Removal

Unscrew the Nut on the Lock.



Lock Cam

Detach the Lock Cam from the Lock.

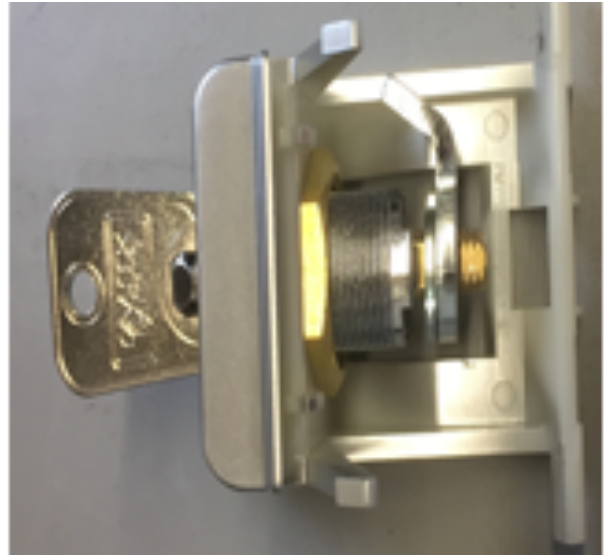

Unscrew the Lock Fixture Nut

Unscrew the Nut which hold the Lock in position.



Lock Removal

Slide the Lock out of its position.



Blank Plug Fitting

Slide the Plug in its position until the clips clip in.

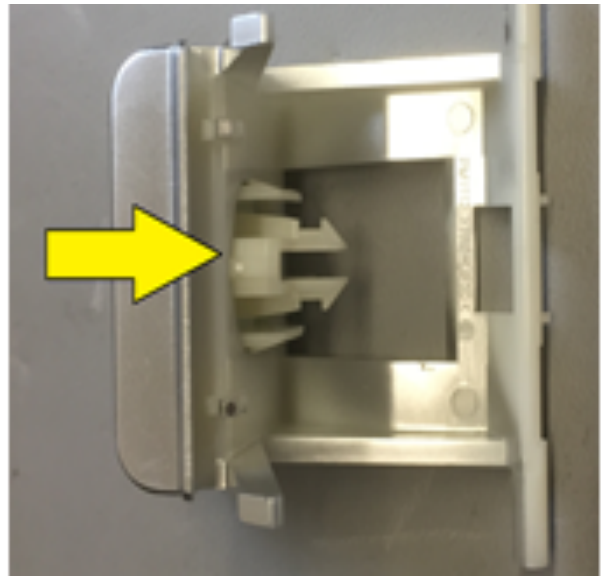

Latch Attachment

Clip the Latch with the Plug back to its Position.



SMART Hopper

Baseplate Removal

Press the Latch on the SMART Hopper to release the SMART Coin System from the Baseplate and slide the SMART Coin System from the Baseplate.

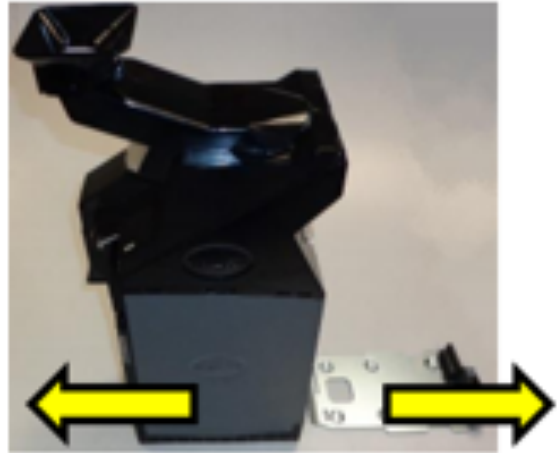

Pressing the Front Latch

Press the Latch on the Coin Feeder to open the Lid of the Coin Feeder.



Pressing the Rear Latch

Press the Rear latch on the Coin Feeder rear to Remove the Coin Feeder from the SMART Hopper.



Detachment of the Coin Feeder

Move the Coin Feeder to the SMART Hopper back. Now move the Coin Feeder up.



Rotate the SMART Hopper

Rotate the SMART Hopper to have the Bottom of the SMART Hopper Up.

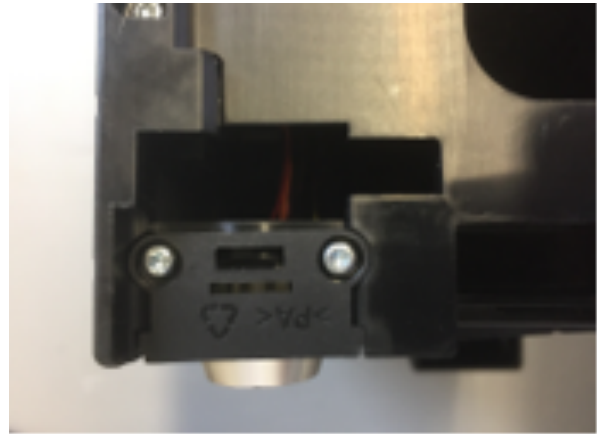

Screw Removal

Unscrew the 2 Screws which fix the Lock Bracket.

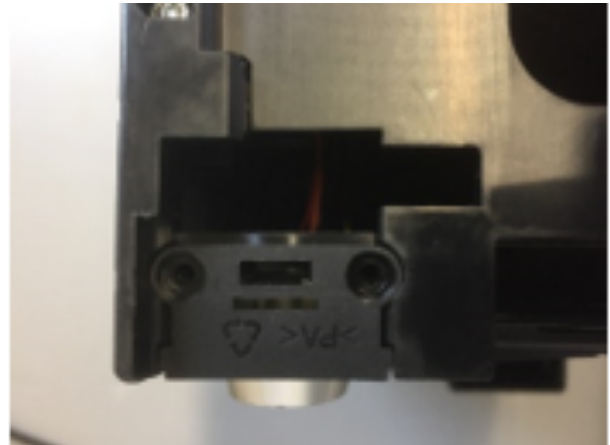

Lock Bracket Removal

Remove the Lock Bracket with an flat screwdriver.



Nut Removal

Unscrew the Nut on the Lock.



Lock Cam

Detach the Lock Cam from the Lock.



Unscrew the Lock Fixture Nut

Unscrew the Nut which hold the Lock in position.



Lock Removal and Blank Plug Fitting

Slide the Lock out of its position and slide the Plug in its position until the clips clip in.

**Bracket Assembly**

Insert the Bracket with the Plug back to its position.

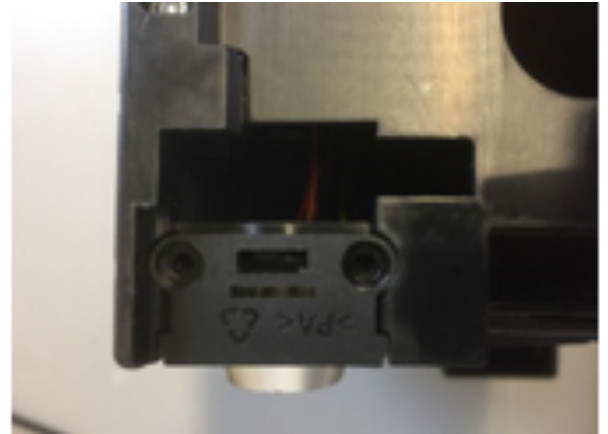
**Screw Onto**

Screw on the Bracket with the Plug.

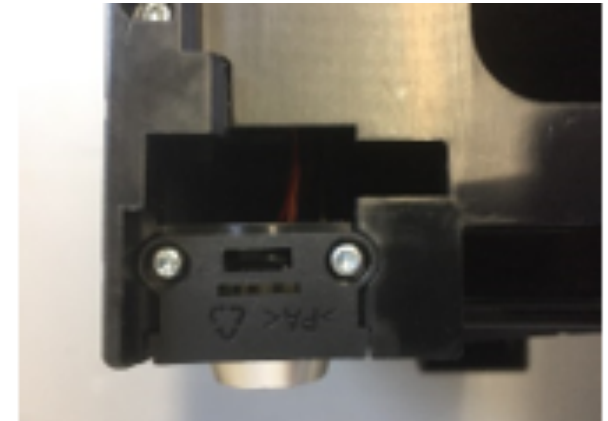

Back to Operation

Rotate the SMART Hopper to its original Position, attach the Coin Feeder and slide the SMART Coin System on the Baseplate.



Lock Specifications

Locks for the SMART Coin System are available from Innovative Technology Ltd.

ITL Part Number: PA00650

Webshop Link: <https://www.innovative-technology.com/product/lock/>

However, there are various lock manufacturers and distributors.

Lock Cam

The following Lock Cam needs to be ordered from Innovative Technology Ltd. additionally to the lock for full locking capability.

ITL Part Number:

SMART Hopper 4 - [MC00211](#)

Coin Feeder - [MC00367](#)

Locking Lid - [MC02525](#)

Machine Mounting

SMART Coin System

Baseplate Removal

Press the Latch on the SMART Hopper to release the SMART Coin System from the Baseplate and slide the SMART Coin System from the Baseplate.

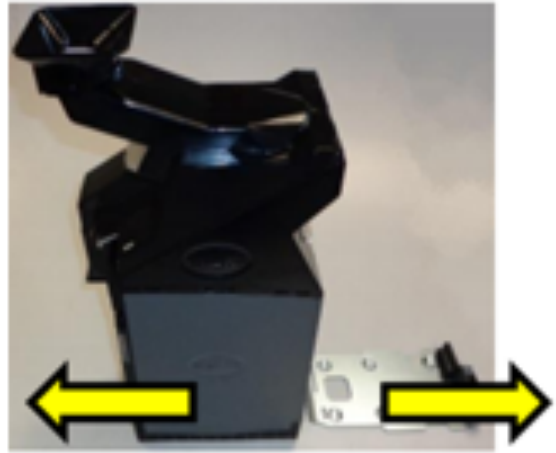

Baseplate Fixture

To Build in the Baseplate in the Host Machine, Screw on the Baseplate with six screws.

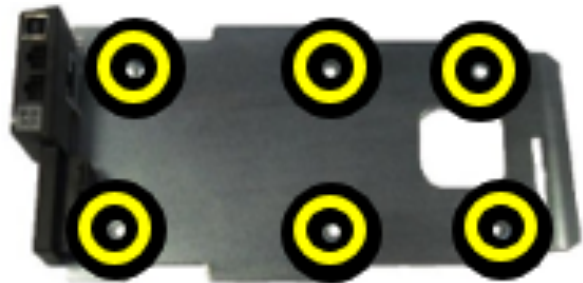

Baseplate Fitting

Slide the SMART Coin System on the Baseplate.

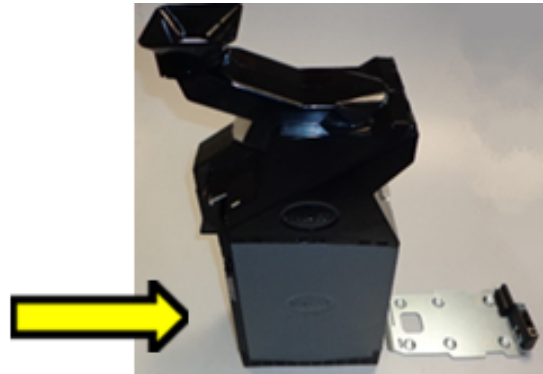

Twin SMART Coin System

Baseplate Removal Primary

Press the Latch on the SMART Hopper to release the SMART Coin System from the Baseplate and slide the SMART Coin System from the Baseplate.



Baseplate Removal Secondary

Press the Latch on the SMART Hopper to release the SMART Hopper from the Baseplate and slide the SMART Hopper from the Baseplate.



Baseplate Fixture

To Build in the Baseplate in the Host Machine, Screw on the Baseplate with eight screws.

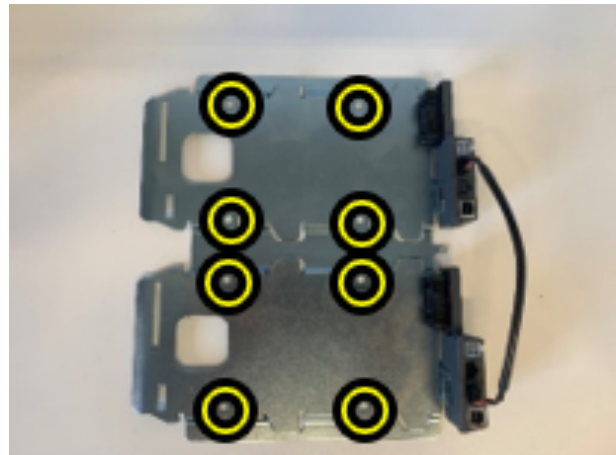

Baseplate Fitting Secondary

Slide the SMART Hopper on the Baseplate.



Baseplate Fitting Primary

Slide the SMART Coin System on the Baseplate.



Earth Bonding

It is very important that the SMART Coin System and TWIN SMART Coin System is properly bonded to earth. Lack of proper bonding can cause communication issues and other failures.

The earth bond should be made to any of the 6 holes in the bottom of the base plate and be bonded to mains earth, typically through the Power Supply Unit.

The resistance between the base plate and the Earth pin on the mains plug should be less than 0.7 ohms.

 Lack of proper earth bonding causes failures!

Additional Earth Bonding in Machine Housing

Where used in a machine where metal parts are in use around the areas where coins are handled (e.g. Coin Input Funnel, Coin Output Bowls or Cashboxes), it is essential that these parts are properly earthed to prevent ESD (Electro Static Discharge) on other host peripherals or the SMART Coin System and TWIN SMART Coin System itself.

Where used in a machine that has a metal host PC box & cover, it is essential that these parts are also properly earthed to prevent ESD on other host peripherals or the SMART Coin System and TWIN SMART Coin System itself.

Additional Recommendations

It is recommended to use shielded cables to prevent ESD issues in the machine. Cables without shielding have a lower resistance than shielded cables and they are more responsive to ESD.

We recommend using suitable cable lengths in the machine housing. A longer cable than required will show more potential sources of error. There is a high potential that an excessively long cable could act as a wireless receiver to ESD.

Screw Specifications

The scope of delivery does not include screws for machine mounting. See table below for screw specification reference.

Type	Head Diameter		Head Height		Bolt Diameter		Bolt Length	
	Min	Max	Min	Max	Min	Max	Min	Max
Flat Head	6mm	11mm	/	3,4mm	/	5mm	/	/
Pan Head	6mm	11mm	/	3,4mm	/	5mm	/	/

SMART Coin System Range Software Installation and Configuration

Contents

- [Introduction](#)
 - [Software Downloads](#)
 - [Drivers](#)
 - [Dataset/Firmware Programming](#)
 - [Validator Manager](#)
 - [SD Card Update](#)
 - [Remote Updates](#)
 - [Managing the Coins - Optimum Use](#)
 - [Coin Level Control Commands](#)
 - [Small Coins](#)
 - [Large Coins](#)
 - [Filling the Unit](#)
 - [Stirring](#)
 - [Coin Routing TWIN SMART Coin System](#)
 - [SH3 Compatibility Mode](#)
-

Introduction

The SMART Coin System and TWIN SMART Coin System leaves the factory pre-programmed with the latest dataset and firmware files. However, it is important to ensure your device is kept up to date with the latest dataset and firmware. This section will give you a brief overview of the various update possibilities with the SMART Coin System and TWIN SMART Coin System. For detailed instructions please refer to the relevant manual package supplied with the software or contact support@innovative-technology.com.

Software Downloads

All software from Innovative Technology Ltd is free of charge and can be downloaded from the website, once registered and logged in. If you are not registered, please create an account via the Create an account form. A confirmation email will be sent to the registered email address once all contact details have been successfully submitted.

Drivers

The ITL drivers allow you to connect any of our validators to a compatible Windows device. If you are connecting via an IF17 then you will not need to follow this process as they are signed Microsoft Drivers and should install automatically. If this isn't the case or your computer is disconnected from the network, there is a standalone package available.

Dataset/Firmware Programming

Validator Manager

General Description

Validator Manager is a utility which allows the user to reprogram any of ITL's validators, hoppers as well as coin and note recycler. Please note that admin rights are required during installation. The validator must be in SSP for the Validator Manager to detect the device.

System Requirements

- Windows 8.1 or above
- .Net Framework 4.5 or above
- 256mb ram
- 50mb hard disk free
- Connected SMART Coin System with active com port



We have seen instances where one of the dll's (itdata1.dll) used in Validator Manager are flagged as a Trojan, this is a false positive and if this happens you will need to add a rule to your antivirus to allow the file to run.

Hardware Setup SMART Coin System

Option 1: Connect the power supply to the SMART Coin System. Connect the USB cable to the IF17 and to your computer or laptop. Connect the SMART Coin System to the IF17 (this is the recommended connection).

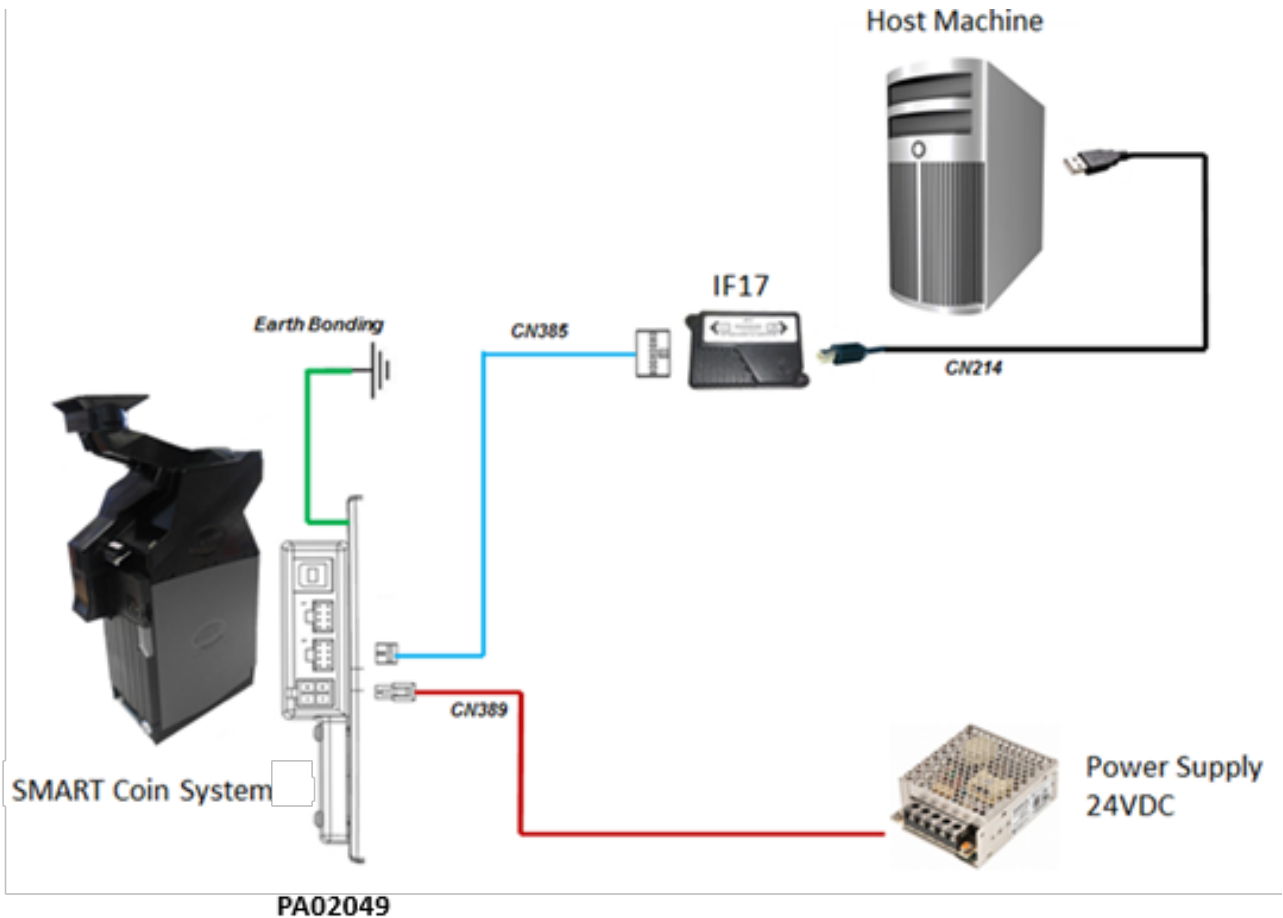

Type	ITL Part Number	Description
Cable	CN00214	USB A to B
Cable	CN00389	SMART Hopper Power cable
Cable	CN00385	SMART Hopper SSP user interface cable
Interface	PA01081	IF17 USB Interface Converter

Type	ITL Part Number	Description
Assembly	PA02049	Mounting Plate Assembly

Option 2: Connect the power supply to the SMART Coin System. Connect the USB cable to the cashbox full sensor/FTDI base (PA03865) and to your computer or laptop. Ensure the base cable (WR02289) is connected as shown in the following schematic diagram.

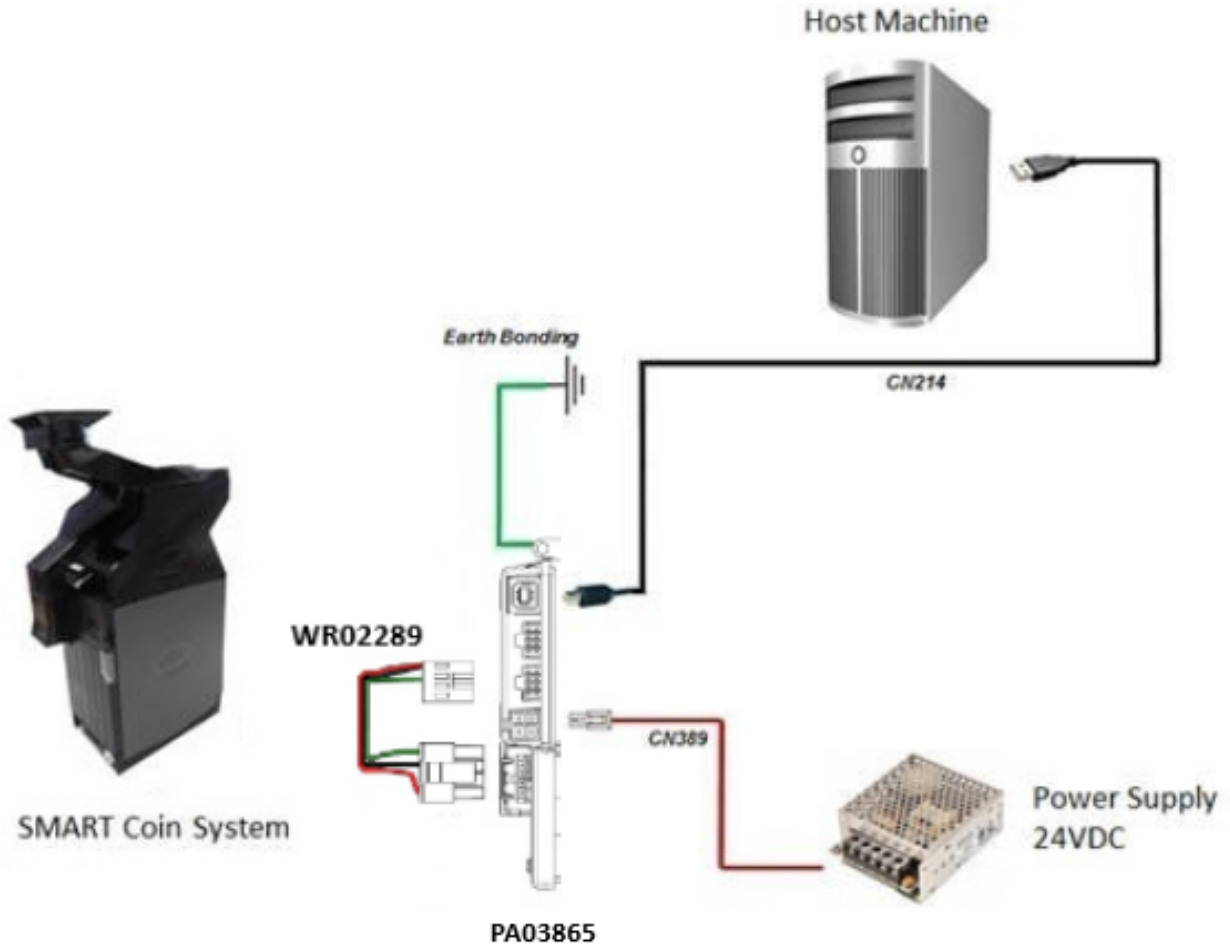

Type	ITL Part Number	Description
Cable	CN00214	USB A to B
Cable	CN00389	SMART Hopper Power cable/
Cable	WR02289	SCS Cashbox Full Sensor Cable
Assembly	PA03865	Mounting Plate Assembly with Cashbox Full Sensor & FTDI

Hardware Setup SMART Coin System with Coin Elevator

Option 1: Connect the power supply to the SMART Coin System. Connect the Coin Elevator to the Baseplate (WR02224). Connect the SMART Coin System baseplate to your computer or laptop using the USB cable.

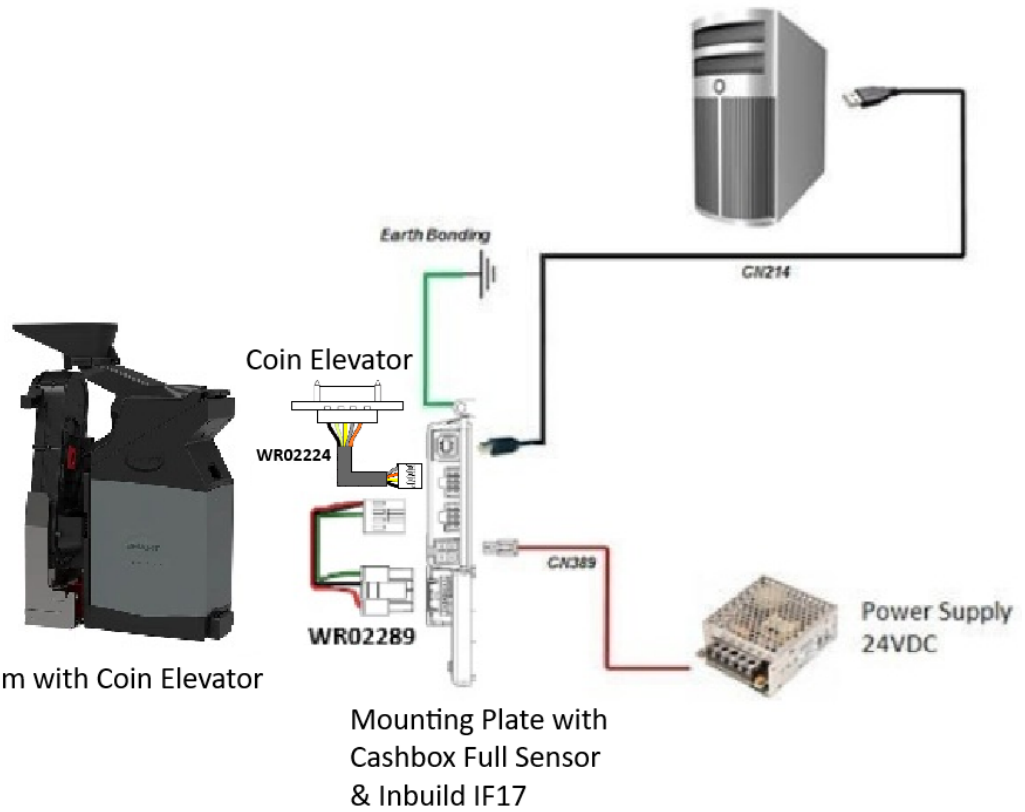

SMART Coin System with Coin Elevator

Mounting Plate with
Cashbox Full Sensor
& Inbuilt IF17

Type	ITL Part Number	Description
Cable	CN00214	USB A to B
Cable	CN00389	SMART Hopper Power cable/
Cable	WR02289	SCS Cashbox Full Sensor Cable
Cable	WR02224	Coin Elevator to Baseplate cable
Assembly	PA03865	Mounting Plate Assembly with Cashbox Full Sensor & FTDI

Hardware Setup TWIN SMART Coin System

Option 1: Connect the power supply to the TWIN SMART Coin System. Connect the USB cable to the IF17 and to your computer or laptop. Connect the TWIN SMART Coin System to the IF17.

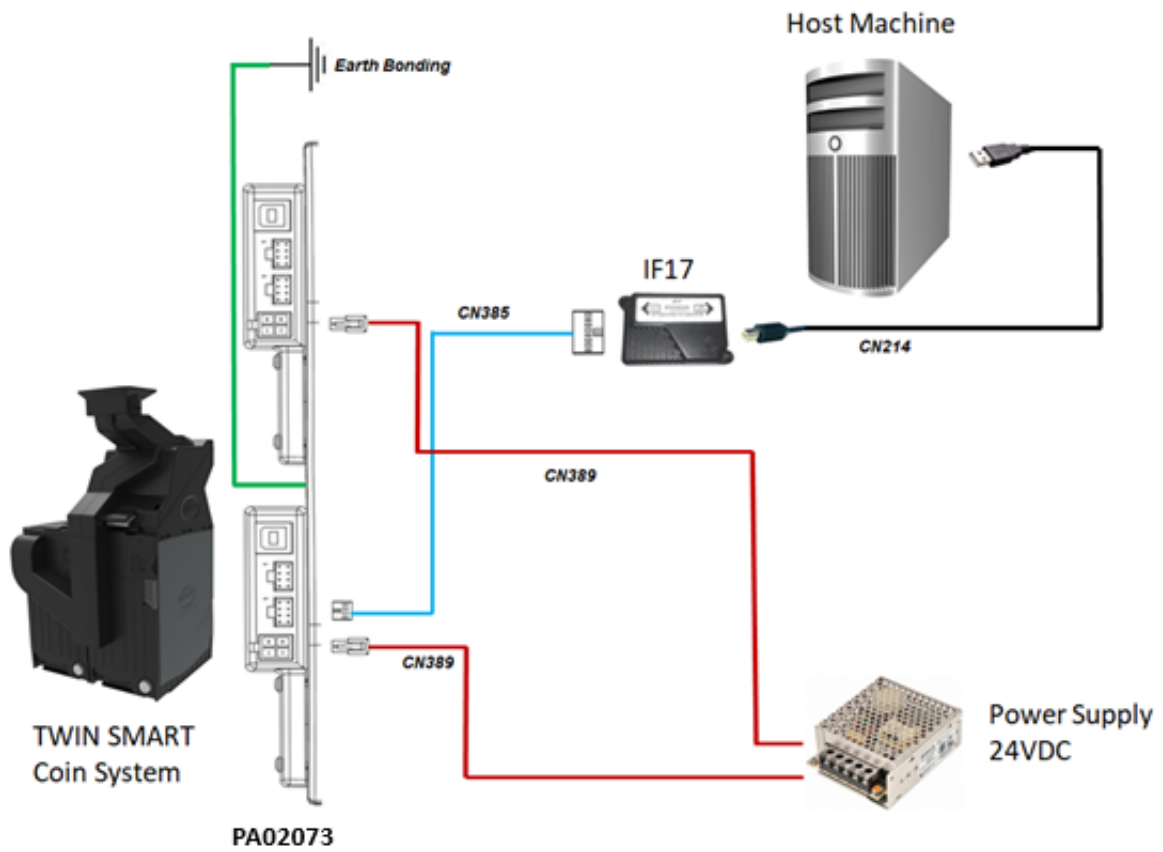

Type	ITL Part Number	Description
Cable	CN00214	USB A to B
Cable	CN00389	SMART Hopper Power cable
Cable	CN00385	SMART Hopper SSP user interface cable
IF17	PA01081	IF17 Dongle - SSP to USB
Assembly	PA02073	Mounting Plate Assembly (R1)

Option 2: Connect the power supply to the TWIN SMART Coin System. Connect the USB cable to the IF17 and to your computer or laptop. Connect the TWIN SMART Coin System to the IF17.

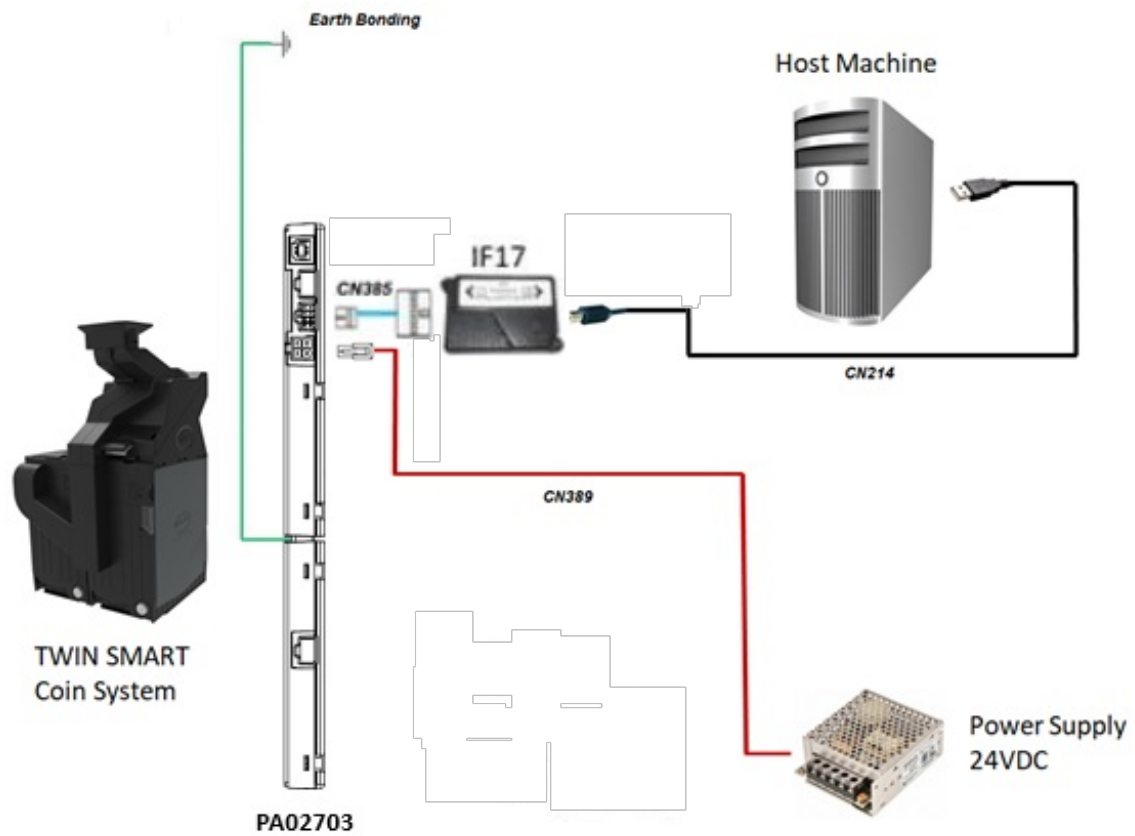

Type	ITL Part Number	Description
Cable	CN00214	USB A to B
Cable	CN00389	SMART Hopper Power cable
Cable	CN00385	SMART Hopper SSP user interface cable
IF17	PA01081	IF17 Dongle - SSP to USB
Assembly	PA02073	Mounting Plate Assembly (R2)

Option 3: Connect the power supply to the TWIN SMART Coin System. Connect the USB cable from the TWIN SMART Coin System base plate to your computer or laptop.

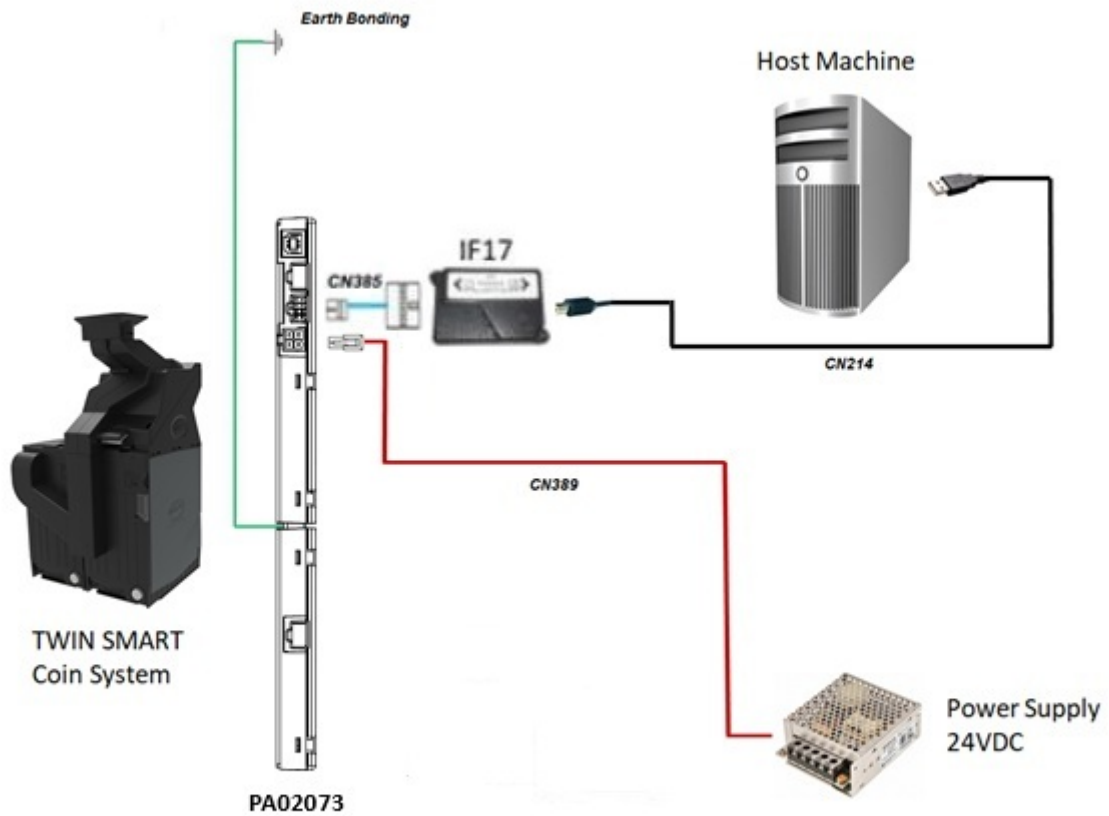

Type	ITL Part Number	Description
Cable	CN00214	USB A to B
Cable	CN00389	SMART Hopper Power cable
Assembly	PA02073	Mounting Plate Assembly (R2)

Hardware Setup SMART Hopper

Option 1: Connect the power supply to the SMART Hopper. Connect the USB cable to the IF17 and to your computer or laptop. Connect the TWIN SMART Coin System to the IF17.

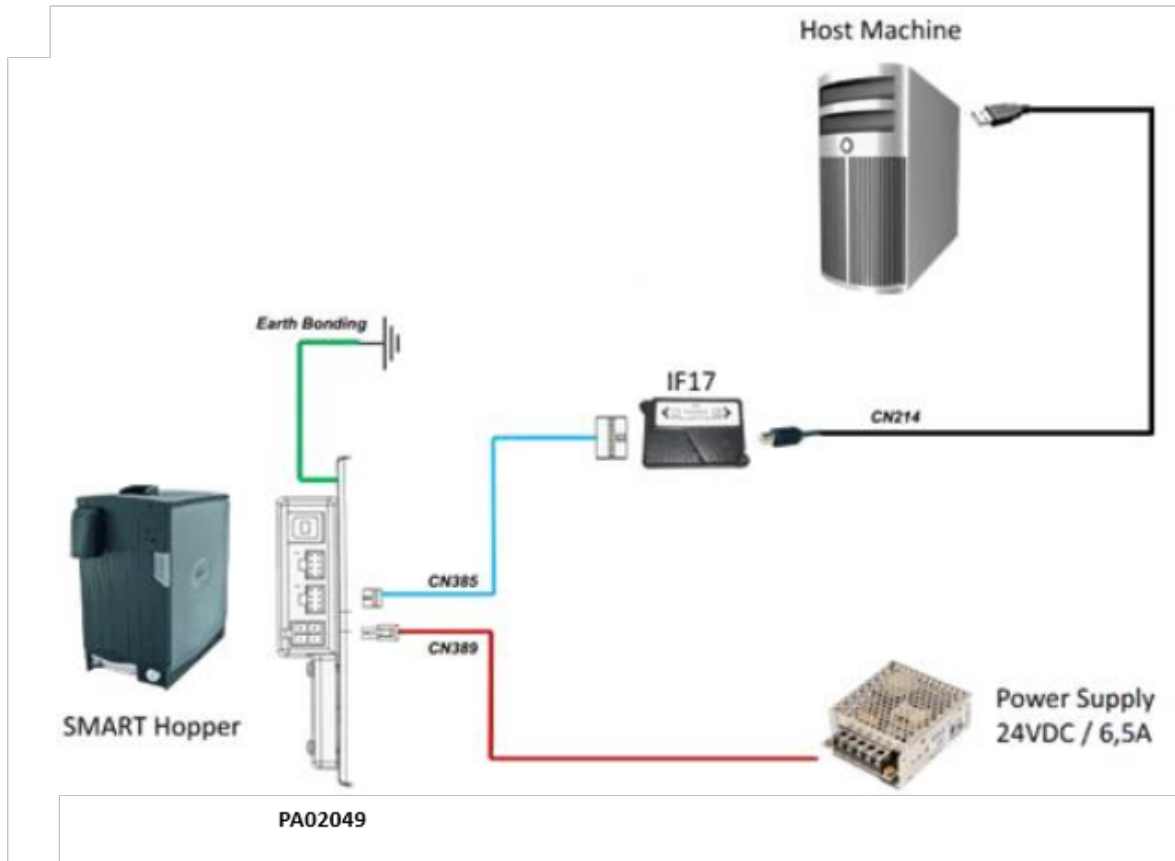

Type	ITL Part Number	Description
Cable	CN00214	USB A to B
Cable	CN00389	SMART Hopper Power cable
Cable	CN00385	SMART Hopper SSP user interface cable
IF17	PA01081	IF17 Dongle - SSP to USB
Assembly	PA02049	Mounting Plate Assembly

Option 2: Connect the power supply to the SMART Hopper. Connect the USB cable from the TWIN SMART Coin System base plate to your computer or laptop.

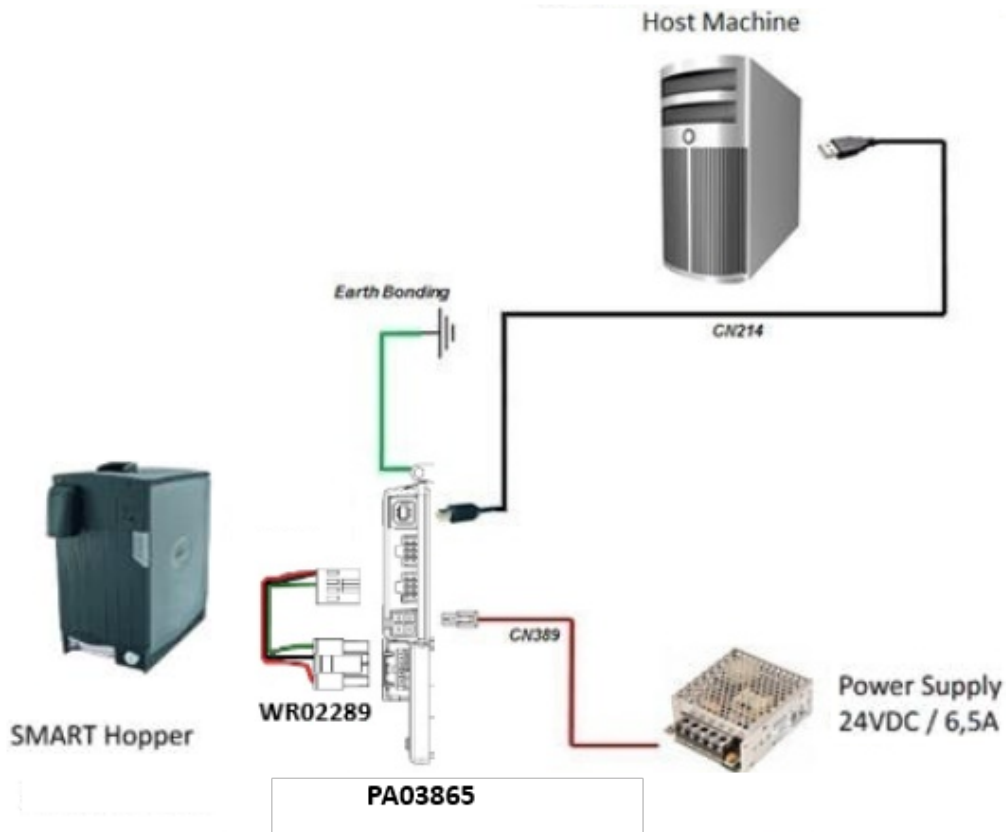

Type	ITL Part Number	Description
Cable	CN00214	USB A to B
Cable	CN00389	SMART Hopper Power cable/
Cable	WR02289	SCS Cashbox Full Sensor Cable
Assembly	PA03865	Mounting Plate Assembly with Cashbox Full Sensor & FTDI

Switching to Programming Mode (SSP)

Before programming via the Validator Manager the SMART Coin System needs to be [switched to its programming mode \(SSP interface\)](#).

Programming the Device

Once you have switched the unit into SSP, open Validator Manager and click detect devices. This will scan all active com ports for a unit, if your SMART Coin System and TWIN SMART Coin System fails to connect please ensure the correct drivers are installed and the unit is in SSP.

By selecting the Program tab, you can reprogram the SMART Coin System or TWIN SMART Coin System. To begin the upload, click open file, then browse to the file location (usually Downloads) before clicking OK.

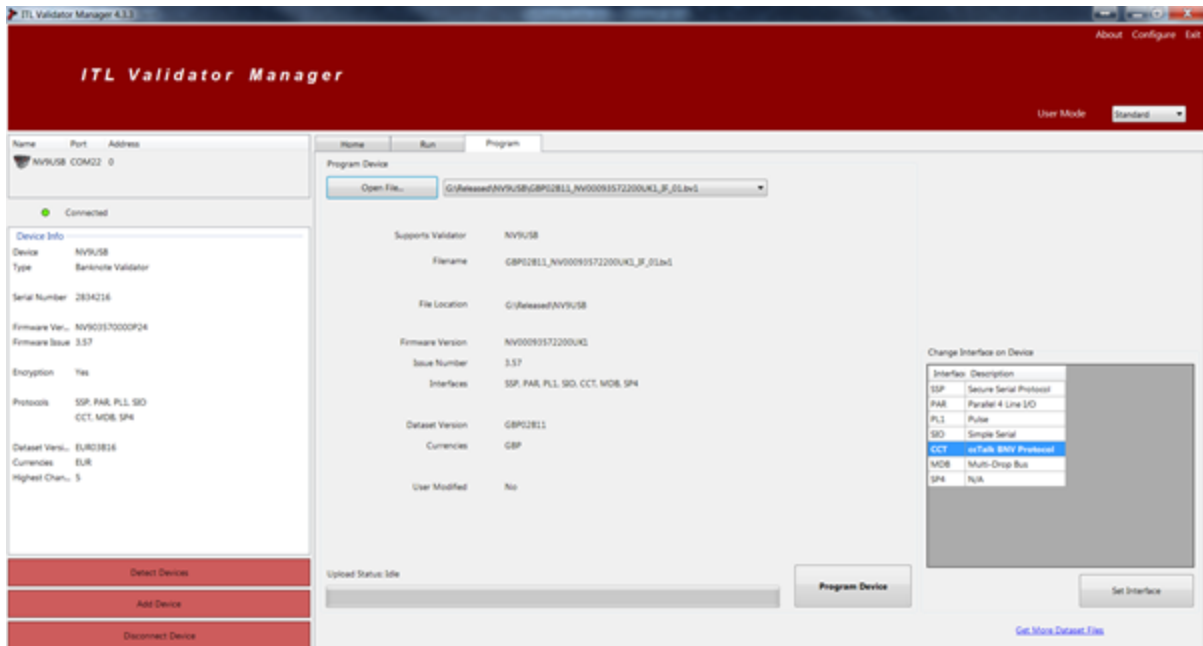

Once the file has been selected its information will be populated and the Program device tab will become active. Finally hit 'Program Device', the unit's Status LED's will now begin to flash signalling the update has begun (alternating Red/Green).

ⓘ Interrupting the download process can result in the unit entering a non-functional state, once the process has started it cannot be halted.

When completed the unit will restart and a pop up box will appear saying Device Programming Complete.

SD Card Update

General Description

Updating the SMART Coin System and TWIN SMART Coin System with a SD Card is a very quick and simple process.

ⓘ Please note that the Primary and Secondary hoppers need to be updated separately.

Hardware Requirements

- Recommended SD-Card tested and verified by Innovative Technology LTD, Part Number **IC02017**
- A computer with a SD Card Reader

Software Requirements

The required SMART Coin System and TWIN SMART Coin System Dataset

For example: EUR01074_SH00041401008C01.cf1

Re-programming via SD Card

ⓘ The power state of the device doesn't affect the update process, it can boot with the SD card or can be inserted once it has been start-up.

- Copy the file on to the SD Card with the file renamed as **update.cf1**
- Place the SD Card in to the SD slot on the front of the Smart Coin System
- During the update the LED lights will alternate between green & red

- Once the update is completed the SMART coin System will reset, turning the motors in the feeder and then the hopper (this can take between 1 and 3 minutes but typically 90 seconds)
- Once this has completed it is safe to remove the SD Card

 Interrupting the download process can result in the unit entering a non-functional state, once the process has started it cannot be halted.

Remote Updates

General Description

As part of our continued development and improvement, Innovative Technology Ltd periodically releases new dataset or firmware for our validators. This could be for improved acceptance, additional features or security updates. We recommend that network connected cabinets and applications communicating in SSP have the functionality to update the devices attached through the application software. We can provide DLLs and libraries to assist with this development. Please contact your local support office with your requirements for more assistance. This section outlines the software processes involved in updating a validator with a new dataset/firmware file. Implementation of this process allows a validator to be updated from a remote location using the host machine software.

Hardware Requirements

Connect the power supply to the SMART Coin System. Connect the USB cable to the IF17 and to your computer or laptop. Connect the SMART Coin System to the IF17.

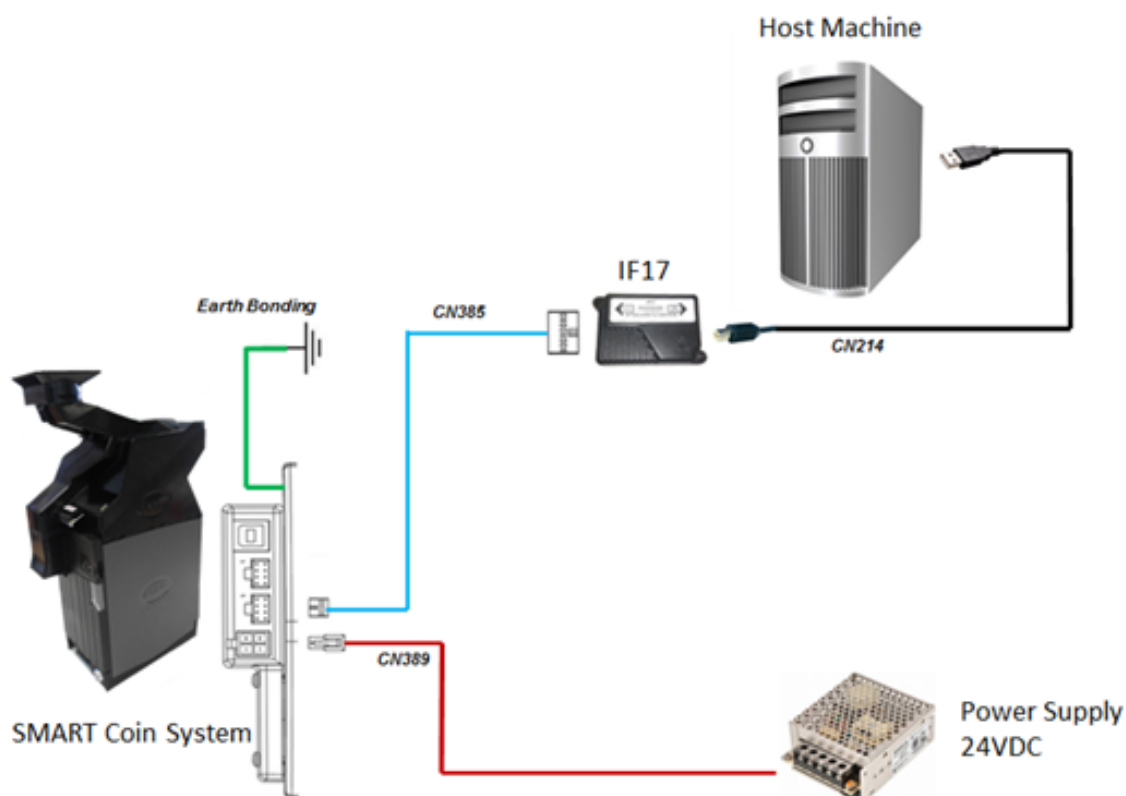

Requirements

- SMART Coin System connected on one com port (typically via IF17)
- SMART Coin System with firmware later than 1.07

Managing the Coins - Optimum Use

To get the best from the SMART Coin System, please observe the following:

- a) Minimum hopper coin levels: the recommended minimum is 20 pieces of each denomination, the absolute minimum is 10 pieces of each denomination or 50 coins, whichever is less. Less than this will result in extended search times for the correct coin or even time-outs.
- b) Maximum hopper coin levels: the maximum is determined by the physical level (height) of the coins held. This is observed and reported by the 'Full Sensor' (optical) in the hopper bowl. It reports using the 'Device Full' 0xCF SSP event. The actual number of coins to reach this level varies with coin sizes and mix. Typical values are approximately 1500 coins.



The host should use the Coin Level Control commands to ensure that the maximum is not exceeded.

Coin Level Control Commands

Coin levels can be controlled using one or more of the following commands:

Float Amount 0x3D

This will float the unit to leave the requested value in the unit. Its benefits are:

- a) Overall Value Control
- b) Calculations are done for you by the SCS

Float by Denomination 0x44

This will float the unit on an individual coin by coin basis to ensure the actual coin levels remain. Its benefits are:

- a) Exact coin levels
- b) The absolute maximum of the coins is not exceeded (see above)
- c) A good mix of coins at all times to meet the payout values required.

Set Cashbox Payout Limit 0x4E

Allows the host to specify a maximum level of each coin, by denomination, to be left in the hopper. Its benefits are:

- a) Floating (paying to cashbox) is done 'invisibly'
- b) Levels are reached automatically
- c) No out-of-service time while floating takes place

Small Coins

Coins below 18mm diameter require special considerations.

During normal operation (payout or stir) the number of the below specified coins in the hopper should not exceed a specified amount or percentage of the total coins – whichever is greater.

If the small coins exceed this level, the SCS will automatically try to dump the excess to cashbox during any operation.

If the small coins exceed this level they should be reduced, as quickly as possible, using the [Coin Level Controls commands](#).

The restrictions are implemented for the following currencies:

Currency	Denomination	Percentage of all coins	Max amount of coins if no other coins in device
EUR (Euro)	0.01€	25%	20
THB (Thai baht)	50 Satang	15%	20

Large Coins

Large coins (coins larger than the largest in the dataset) can block the recesses in the Coin Feeder disk. In the worst cases this would mean that the normal coins cannot be fed into the hopper.

It is extremely unlikely that this would happen in normal operation. Even so, the SCS monitors for this and if this happens, after a coin feeder activation zero coins are seen in the validation area then the unit will issue a Maintenance Required SSP message (0xC0). This is a warning that the host machine can use to call the site operator to check the unit.

Filling the Unit

When filling with a roll* of coins put only one roll* of coins into the feeder at one time. Wait for the coins to be completely processed before introducing more coins.

If filling with rolls* of different denominations, if possible use the rolls in a mixed order i.e. do not put all the same denomination in at the same time. This will help mix the coins from the start.

When filling with mixed coins, insert 150 coins maximum at one time. Wait for these to be processed before introducing more coins.

Note: During refill some coins may be rejected in the normal way. These should be re-entered once the previous lot have been processed.

*Typical EURO Coin Roll Sizes:

Denomination	Amount of Coins per Roll
0,01€	50 Coins per roll
0,02€	50 Coins per roll
0,05€	50 Coins per roll
0,10€	40 Coins per roll
0,20€	40 Coins per roll
0,50€	40 Coins per roll
1,00€	25 Coins per roll
2,00€	25 Coins per roll

Stirring

Stirring is the way of mixing the coins without paying any coins out.

After filling the SCS it is recommended that the Coin Stir command is issued (0x5D) with a duration of at least 30 seconds. This will help to ensure optimum payout times for the customer.

Coin Routing TWIN SMART Coin System

Coin Routing via SSP Commands

For the optimum coin handling on the TWIN SMART Coin System, two new Routing commands are added to the SSP protocol.

Sorter Set Routing 0x85

A command to setup the desired route used for a coin denomination accepted by the Feeder. The coin route can be to the primary hopper or to the secondary hopper.

Structure: HEADER BYTES + Expansion header (0x30) + 0x05 + Expansion Command (0x85) + 1 byte of desired sorter path (0x00= Primary Route,0x01= Secondary Route) + 4 bytes of coin value + 3 bytes of country code.

Data received: ACK (0xF0) if all ok + 1 byte of data (0x00= Primary Route, 0x01= Secondary Route), command not processed (0xF5) otherwise.

The command not processed can be received in the following situations:

- The command is sent during a pay-in or a pay-out.
- The routes sent are different to the available (0x00) or (0x01).
- The coin value and/or the country code is not available in the dataset.
- The SCS is not in Twin Mode

Sorter Get Route 0x86

A command to request the sorter route setting of a coin denomination value in the Feeder.

Structure: HEADER BYTES + Expansion header (0x30) + 0x05 + 1 byte of Expansion Command (0x86) + 4 bytes of coin value + 3 bytes of country code.

Data received: ACK (0xF0) if all ok + 1 byte of data (0x00= Primary Route, 0x01= Secondary Route), command not processed (0xF5) otherwise.

The command not processed can be received in the following situation:

- The coin value and/or the country code is not available in the dataset.

Coin Routing via TWIN SMART System Config

Connect the power supply to the TWIN SMART Coin System. Connect the USB cable to the IF17 and to your computer or laptop. Connect the TWIN SMART Coin System to the IF17.

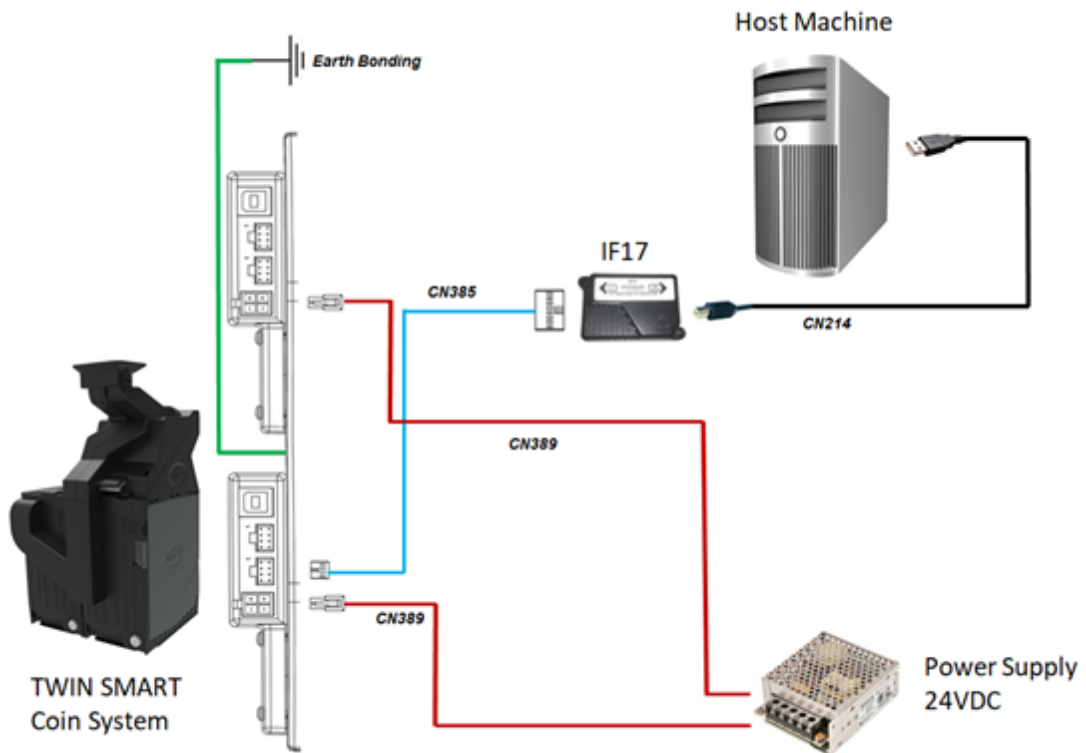

Once you have switched the unit into SSP, open TWIN SMART System Config and click detect devices. If your TWIN SMART Coin System fails to connect please ensure the correct drivers are installed and the unit is in SSP.

If the unit is connected the following screen will appear:

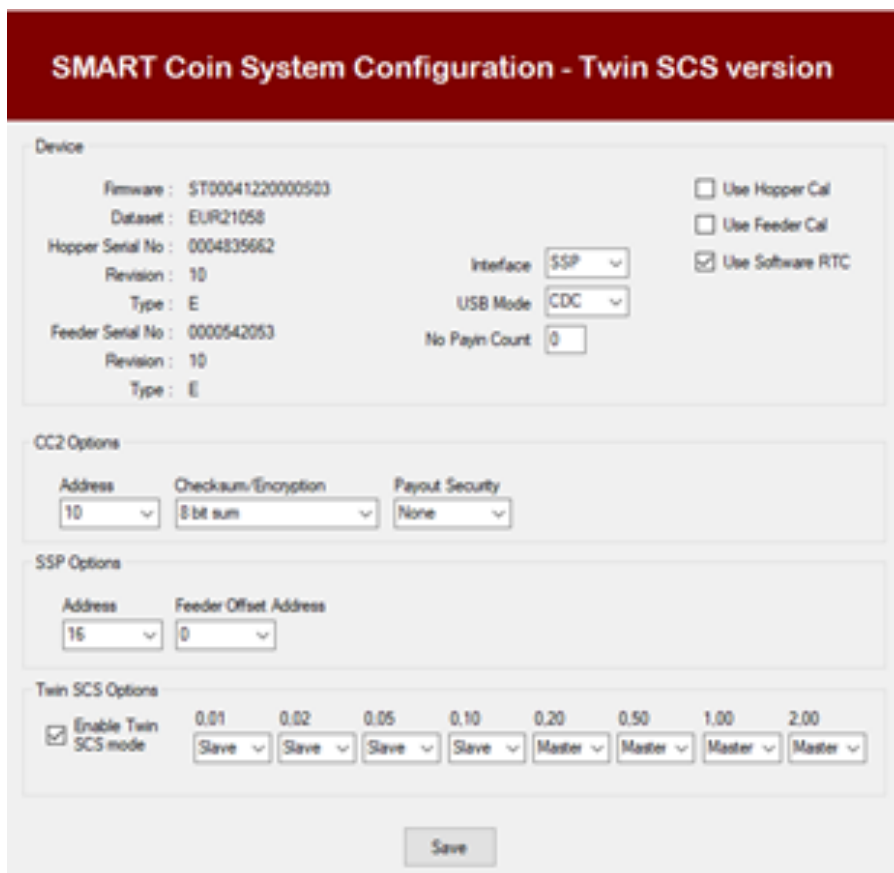

In the section TWIN SCS Options the channel routing can be set (Secondary or Primary):

Twin SCS Options

Enable Twin SCS mode

0.01	0.02	0.05	0.10	0.20	0.50	1.00	2.00
Slave	Slave	Slave	Slave	Master	Master	Master	Master

If the required channel routing is set, confirm your setting on the Save Button:

Twin SCS Options

Enable Twin SCS mode

0.01	0.02	0.05	0.10	0.20	0.50	1.00	2.00
Slave	Slave	Slave	Slave	Master	Master	Master	Master

If the routing was successfully set a confirmation message will be displayed:

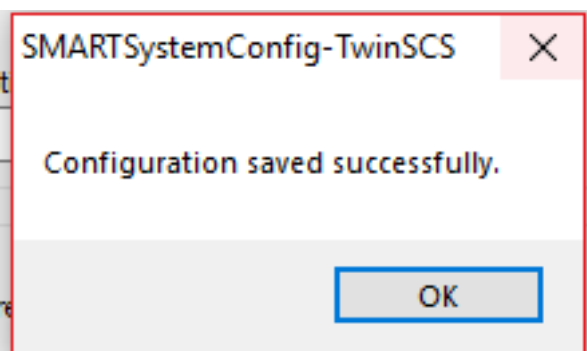

SH3 Compatibility Mode

To aid in backwards compatibility with SMART Hopper 3 a new option has been created which changes some of the functions of how the SMART Hopper 4 operates compared to its normal operation when combined with a Coin Feeder to create the SMART Coin System.

Once set SMART Hopper 4 will operate as below:

- Protocol version defaults to 5
- SSP event 0xDF Coin Credit is given instead of 0xBF Value Added like SCS
- SSP event 0xB7 Coin Mech Error has additional reason byte
- SSP event 0x83 Calibration Error will give only 1 reason byte
- Added SSP commands 0x47 Set Calibration Mode and 0x48 Run Device Calibration

 Coin Mech support direct to baseplate in SSP protocol only.

SMART Coin System Range Protocols and Interfacing

Contents

- [Introduction](#)
- [SSP and eSSP](#)

Introduction

The SMART Coin System and TWIN SMART Coin System supports standard industry protocols. Interfaces that are not listed may be available upon request. For any queries regarding interfaces that are not listed please contact support@innovative-technology.com.

 The use of an encrypted protocol (preferable eSSP) is strongly recommended to achieve the highest security!

SSP and eSSP

General Description

Smiley[®] Secure Protocol (SSP) and Encrypted Smiley[®] Secure Protocol (eSSP) are field proven secure interfaces specifically designed by Innovative Technology Ltd. to address the problems by cash handling systems in gaming machines. Problems such as acceptor swapping, re-programming acceptors and line tapping are all addressed. This interface is recommended for all new designs. Innovative Technology Ltd. provides full SDK packages upon request including Interface Specification, Implementation Guide as well as source code examples for C++, C# & .NET. Please contact support@innovative-technology.com for further information.

Pin Assignments

All the connectors needed to set up the SMART Coin System and TWIN SMART Coin System are easily accessible on the bottom base: there are two connectors that are used to allow interfacing and programming:

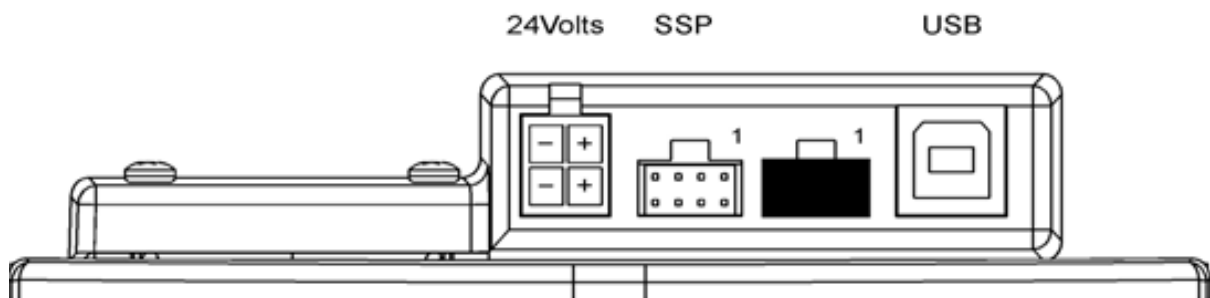

 +24VDC and 0V (GND) must always be connected, also when using USB connections.

The first connector is a 4-pin socket used to power up the SMART Coin System or TWIN SMART Coin System. The pins 1 & 3 and 2 & 4 are linked and could be used as supply voltage for further devices.

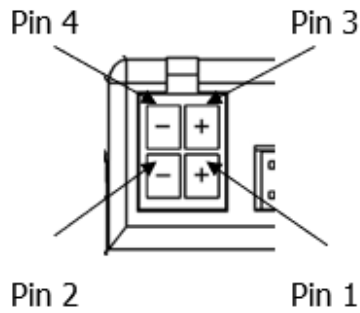

Pin	Description
1	V+ Power connection
2	0V / Ground Connection
3	N/C
4	N/C

Interface communication from the SMART Coin System and TWIN SMART Coin System unit to the host machine can communicate via SSP or CC2.

The SSP pin numbering of the socket is shown below, as well as an overview of the socket connections:

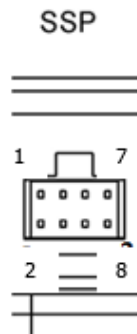

Pin	Description
7	Serial Data In (Rx)
8	Serial Data Out (Tx)
2	Ground Connection

The USB connector is a standard Type B USB socket. The USB socket can be used for programming the SMART Coin System and TWIN SMART Coin System unit and also bench testing – a USB 2.0 compliant Type ‘A’ to ‘B’ lead can be used to do this. USB cables should be electrically shielded and less than 5 metres long.

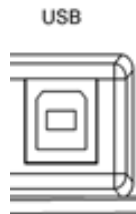

Direct USB should NOT be used for Host communications. If USB is required, then an IF17 (TTL to USB) should be used.

Setup Examples

The drawings below highlights how to connect the SMART Coin System to an SSP or eSSP host machine using available cables and interfaces from Innovative Technology Ltd.

SSP Setup - SMART Coin System

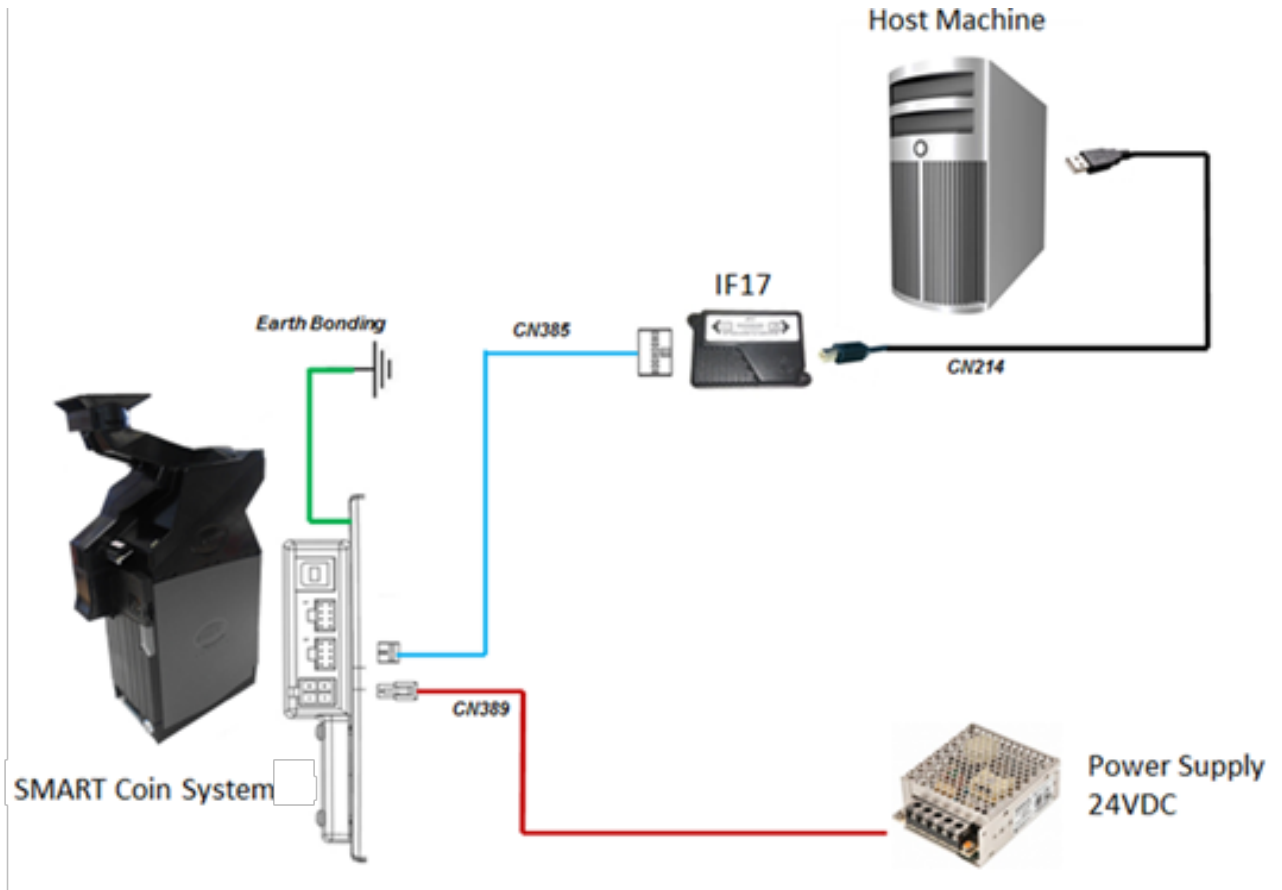

PA02049

Type	ITL Part Number	Description
Interface	PA01081	IF17 USB Interface Converter
Cable	CN00385	Smart Hopper to IF17 cable
Cable	CN00389	Hopper Interface Power Cable
Cable	CN00214	USB A to B Cable Assembly
Assembly	PA02049	Mounting Plate Assembly

SSP Setup - SMART Coin System with Coin Elevator

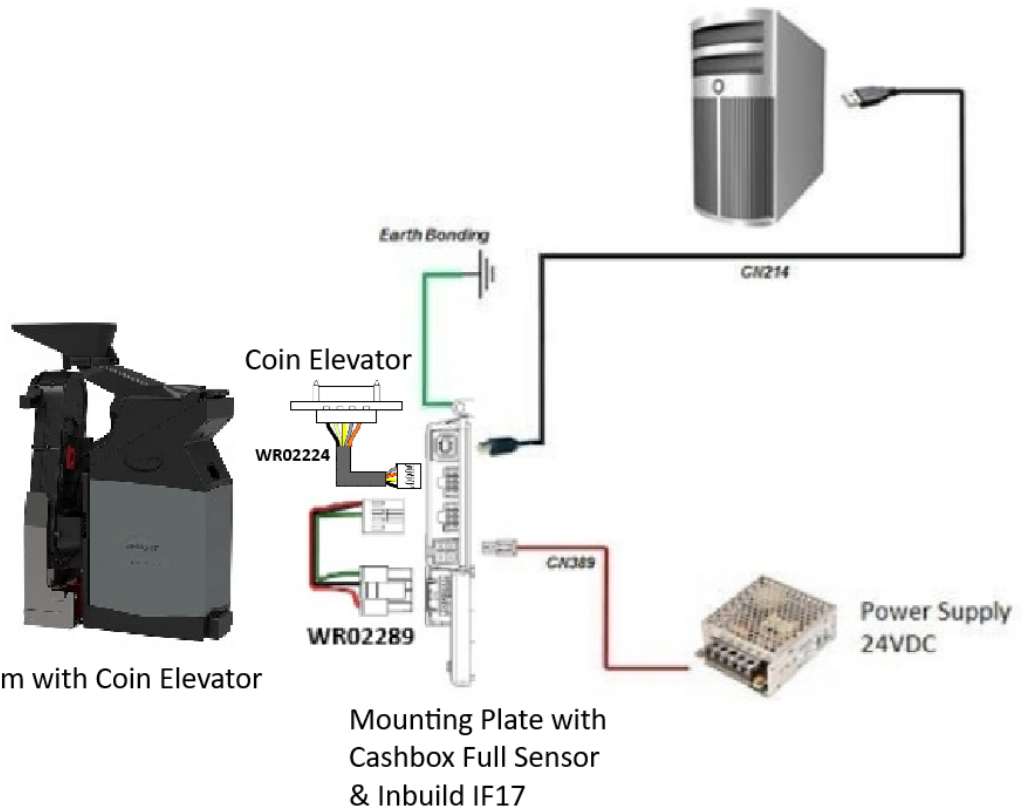

SMART Coin System with Coin Elevator

Mounting Plate with
Cashbox Full Sensor
& Inbuild IF17

Type	ITL Part Number	Description
Cable	CN00389	Hopper Interface Power Cable
Cable	CN00214	USB A to B Cable Assembly
Cable	WR02289	SCS Cashbox Full Sensor Cable
Cable	WR02224	Coin Elevator to Baseplate Cable
Assembly	PA03865	Mounting Plate Assembly with Cashbox Full Sensor & FTDI

SSP Setup - SMART Coin System and SMART Payout

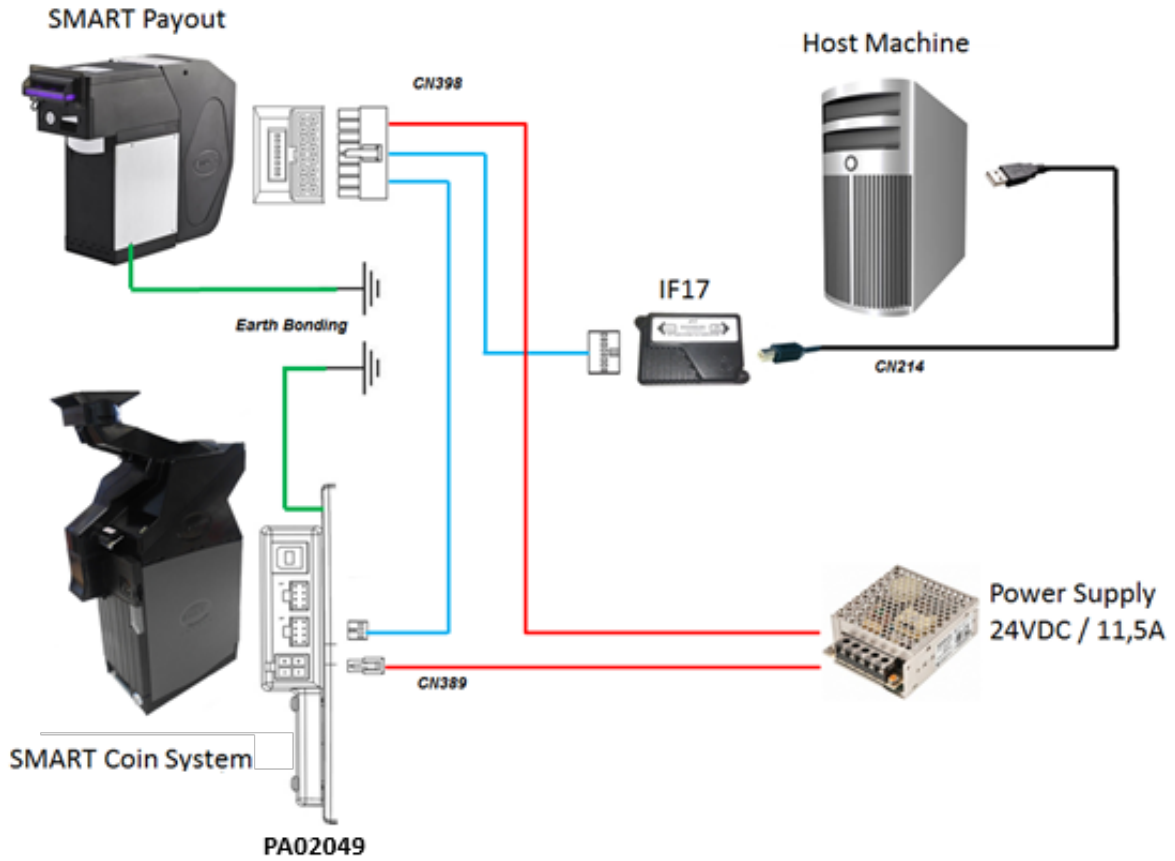

Type	ITL Part Number	Description
Interface	PA01081	IF17 USB Interface Converter
Cable	CN00398	Dual eSSP interface for SMART Hopper & SMART Payout
Cable	CN00389	Hopper Interface Power Cable
Cable	CN00214	USB A to B Cable Assembly
Assembly	PA02049	Mounting Plate Assembly

SSP Setup - SMART Payout and SMART Coin System (Mounting Plate with Cashbox Full Sensor & Inbuilt IF17)

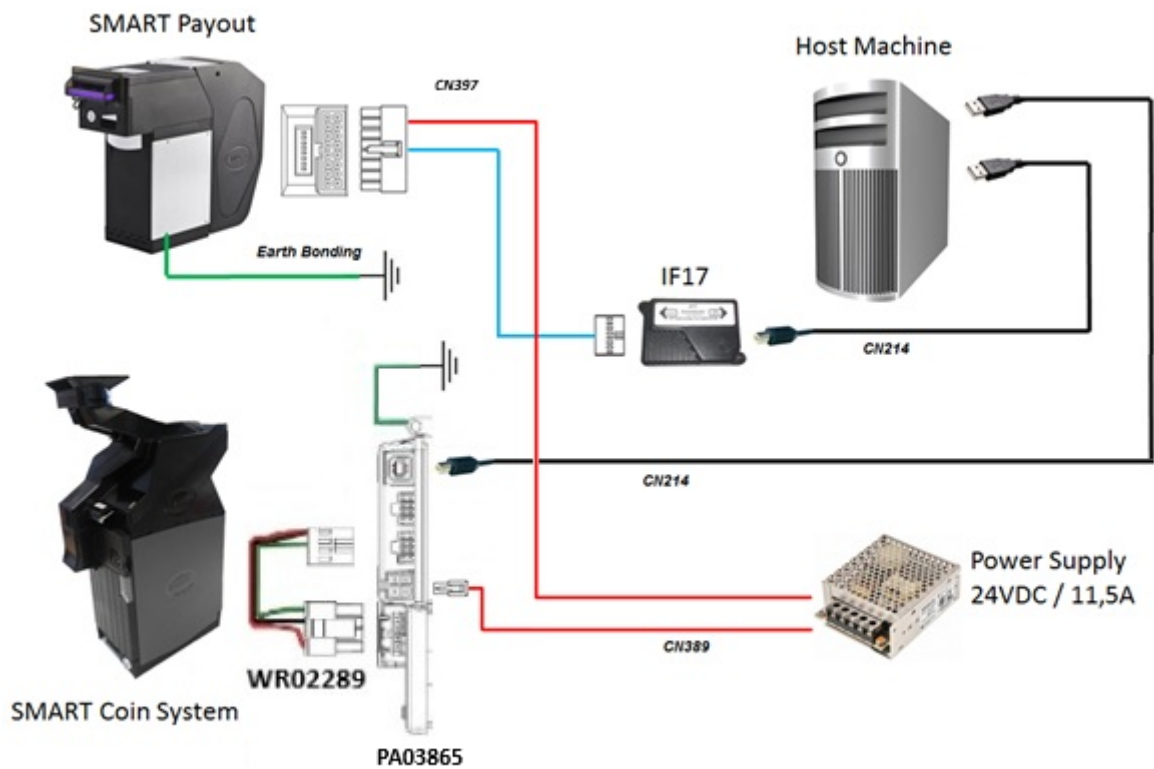

Type	ITL Part Number	Description
Interface	PA01081	IF17 USB Interface Converter
Cable	CN00397	SMART Payout to host cable
Cable	CN00389	Hopper Interface Power Cable
Cable	CN00214	USB A to B Cable Assembly
Cable	CN00214	USB A to B Cable Assembly
Cable	WR02289	SCS Cashbox Full Sensor Cable
Assembly	PA03865	Mounting Plate Assembly with Cashbox Full Sensor & FTDI



The WR02289 cable is not available for separate sale. It is only included within the PA03865 assembly.

SSP Setup - TWIN SMART Coin System

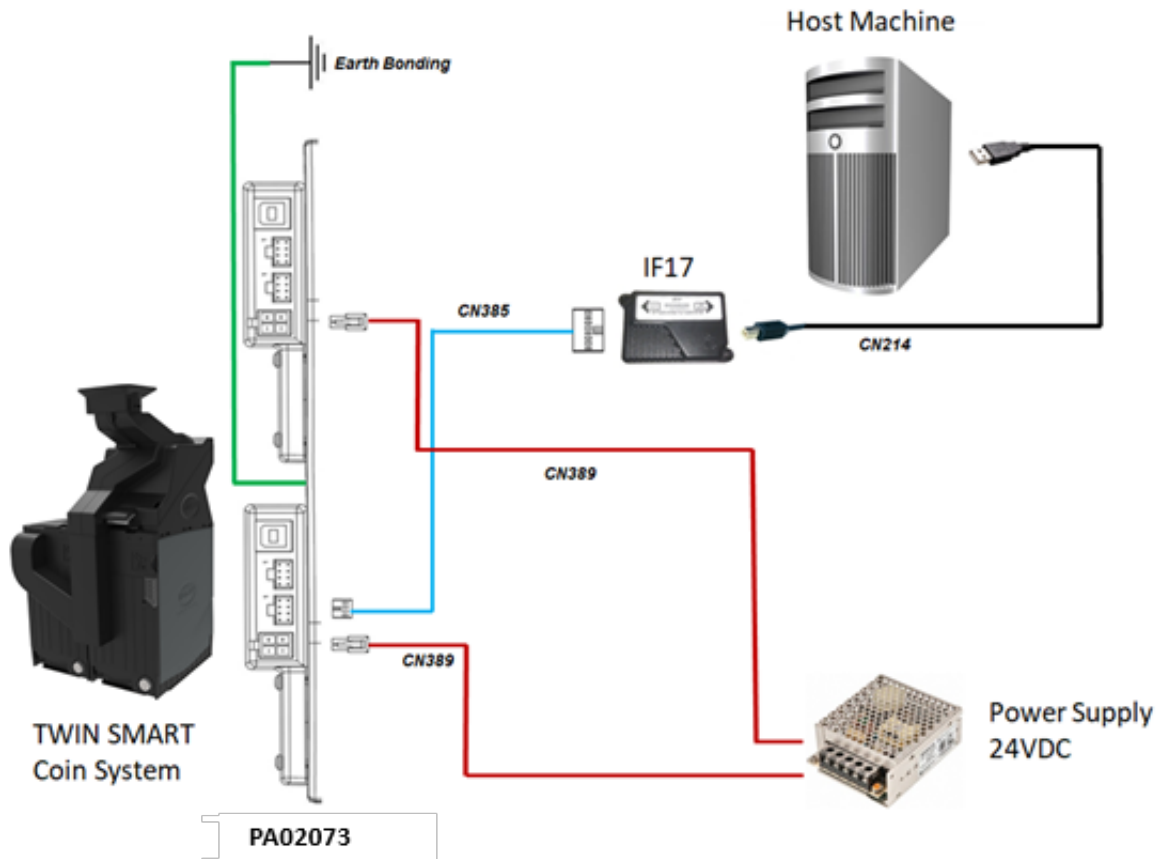

Type	ITL Part Number	Description
Interface	PA01081	IF17 USB Interface Converter
Cable	CN00385	Smart Hopper to IF17 cable
Cable	CN00389	Hopper Interface Power Cable
Cable	CN00214	USB A to B Cable Assembly
Assembly	PA02073	Mounting Plate Assembly (R1)

SSP Setup - TWIN SMART Coin System (Mounting Plate V2)

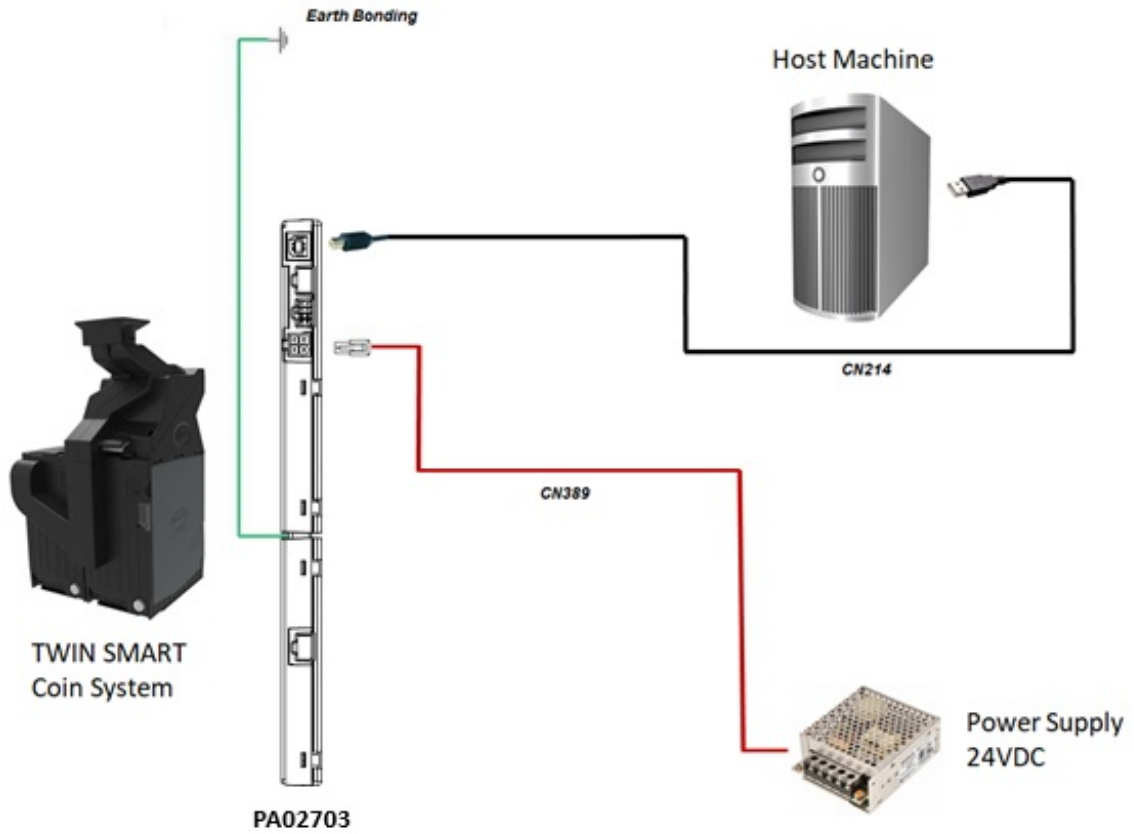

Type	ITL Part Number	Description
Cable	CN00389	Hopper Interface Power Cable
Cable	CN00214	USB A to B Cable Assembly
Assembly	PA02703	Twin Mounting Plate (R2)

SSP Setup - SMART Hopper

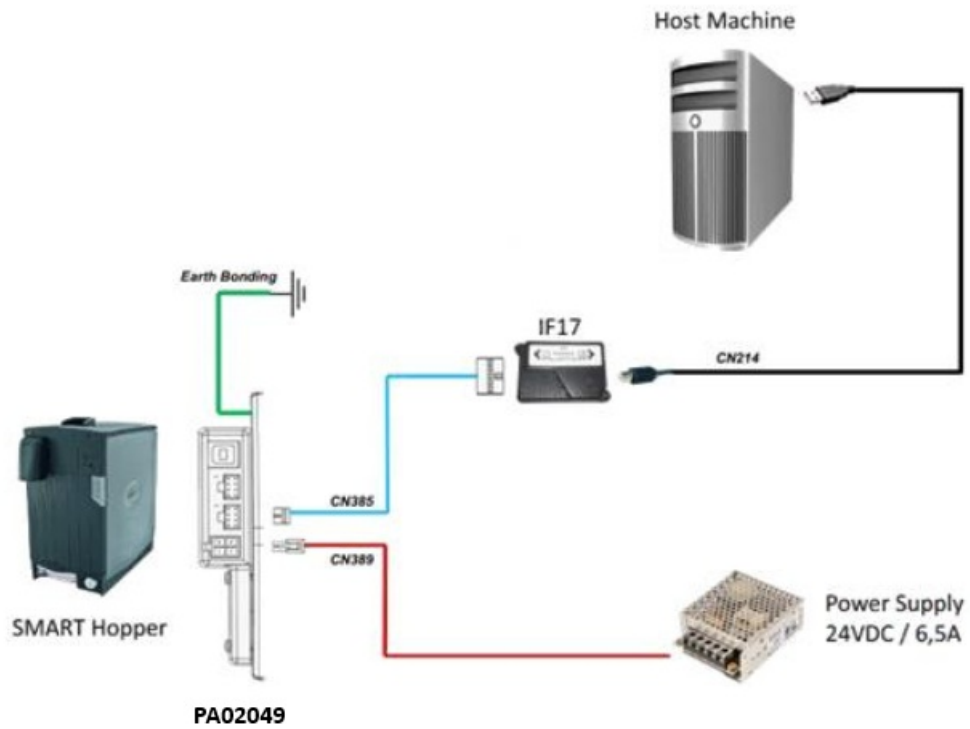

Type	ITL Part Number	Description
Interface	PA01081	IF17 USB Interface Converter
Cable	CN00385	Smart Hopper to IF17 cable
Cable	CN00389	Hopper Interface Power Cable
Cable	CN00214	USB A to B Cable Assembly
Assembly	PA02049	Mounting Plate Assembly

SSP Setup - SMART Hopper (Mounting Plate with Cashbox Full Sensor & Inbuilt IF17)

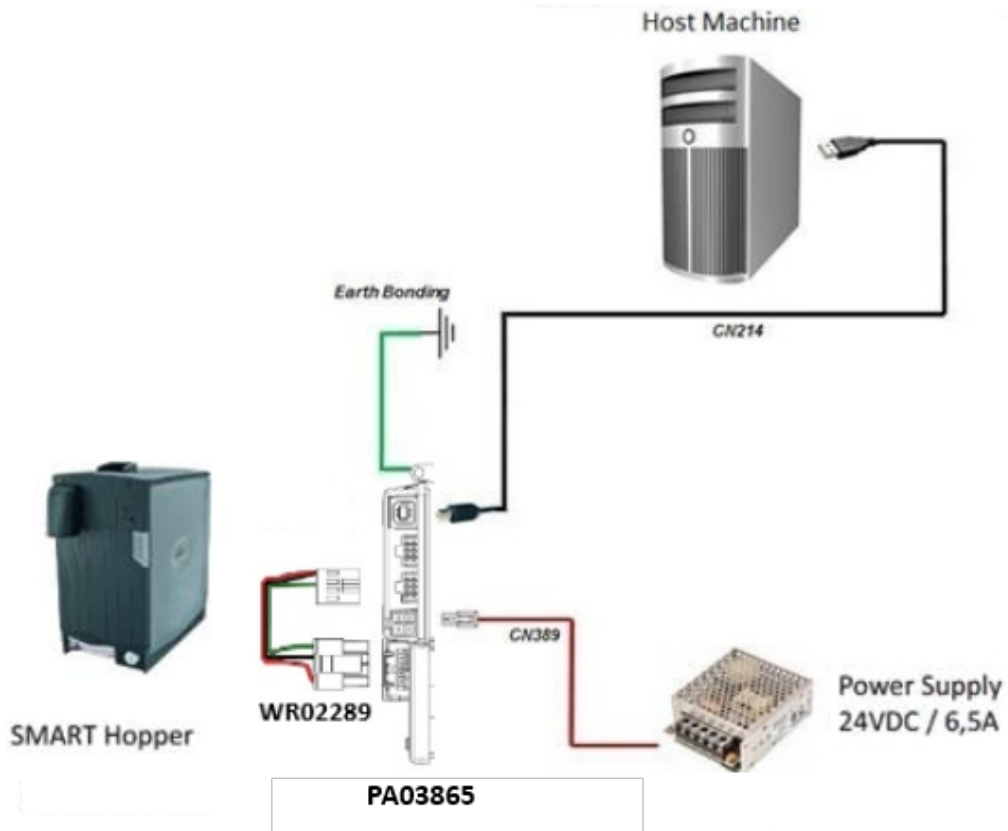

Type	ITL Part Number	Description
Cable	WR02289	SCS Cashbox Full Sensor Cable
Cable	CN00389	Hopper Interface Power Cable
Cable	CN00214	USB A to B Cable Assembly
Assembly	PA03865	Mounting Plate Assembly with Cashbox Full Sensor & FTDI



The WR02289 cable is not available for separate sale. It is only included within the PA03865 assembly.

SMART Coin System Range Service Guide

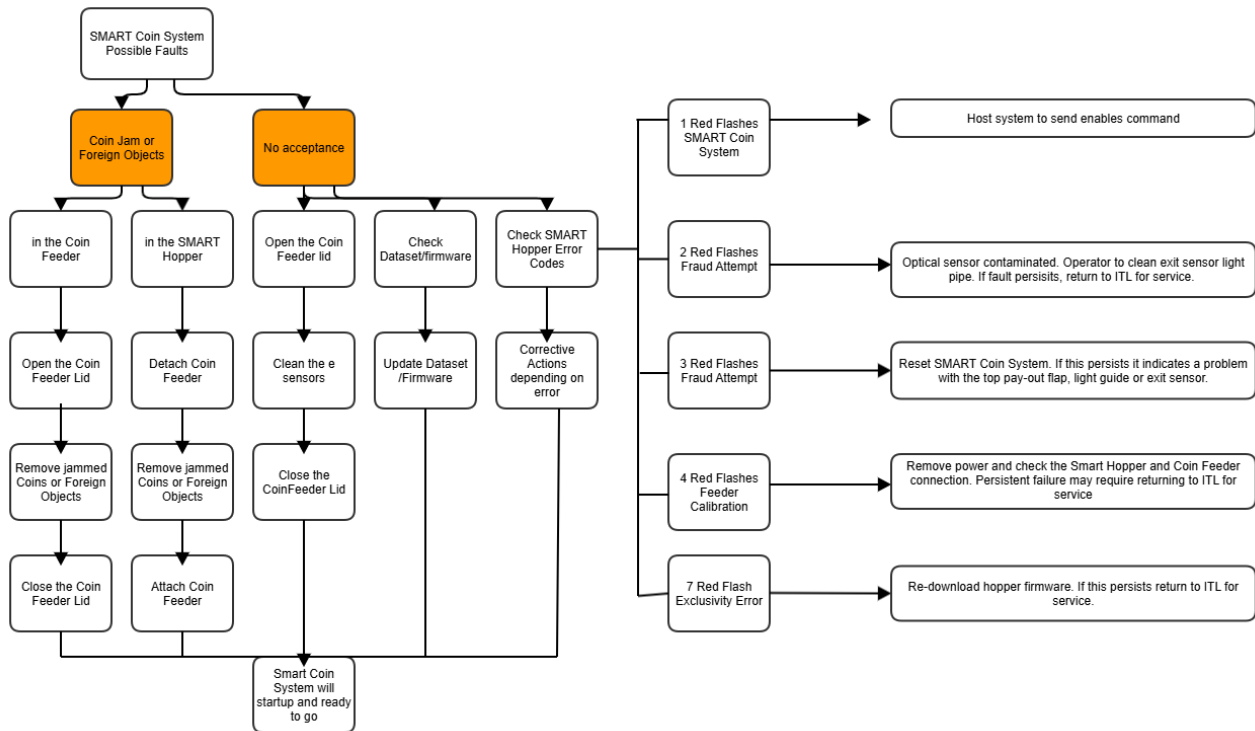

Contents

- Routine Maintenance
 - Introduction
 - Recommended Cleaning Intervals
 - Task Overview
 - Cleaning the SMART Hopper
- Silicone Lubricant Instruction
 - Coin Feeder Top Assembly
 - Coin Feeder Base Assembly
- Status LED Flash Codes SMART Coin System
- Status LED Flash Codes TWIN SMART Coin System
- Error LED Flash Codes
- Fault Finding Flow Chart
- Troubleshooting via SD Card
 - General Description
 - Hardware Requirements
 - Data Collection
 - Analyse the SD Card Data
- Clearing a Jam
 - Clearing a Jam from the Coin Feeder
 - Clearing a Jam from the Hopper
- Checking Power Connections
- Checking Communication Connections
- Checking the Primary and Secondary Link
- Cleaning the SMART Coin System
 - Cleaning the Coin Feeder
 - Disk Removal
- Coin Feeder Path Insert Exchange Instruction
 - Coin Feeder Path Insert Part Numbers

Routine Maintenance

Introduction

The SMART Hopper, SMART Coin System and TWIN SMART Coin System has been designed to minimise any performance variation over time. Much of this is achieved by careful hardware and software design. However, depending upon the environment the SMART Hopper, SMART Coin System and TWIN SMART Coin System may at some time require cleaning, belt changing or coin path clearing.

Recommended Cleaning Intervals

Innovative Technology Ltd recommends cleaning the optical lenses every month or as required. Dirt, dust or other residue leads to bad coin acceptance and other performance degradation.

Task Overview

Recommended Interval	Affected Component	Affected Hardware Type	Recommended Task	Details can be found in Section
Monthly	SMART Hopper	All	Remove the Coin Dust, foreign objects or dirt with a paintbrush, compressed air or a cloth with mild detergent.	Cleaning the SMART Hopper
Monthly	Coin Feeder	All	Coin Path; Remove the Coin Dust, foreign objects or dirt with a paintbrush, compressed air or a cloth with mild detergent.	Cleaning the Coin Feeder
Monthly	Coin Feeder	All	Coin Feeder side exit, Remove the Coin Dust, foreign objects or dirt with a paintbrush, compressed air or a cloth with mild detergent	
Monthly	Coin Elevator	All	Remove the Coin Dust, foreign objects or dirt with a paintbrush, compressed air or a cloth with mild detergent.	

Recommended Interval	Affected Component	Affected Hardware Type	Recommended Task	Details can be found in Section
Every 1,000,000 cycles	SMART Hopper	All	Exchange the Coin Sorting Disk.	Please contact the Support team about this point (Repair Training is required for this task)
Every 250,000 cycles	Coin Feeder	All	Exchange the Coin Sorting Disk.	Disk Removal Coin Feeder
Every 50,000 cycles	Coin Feeder	All	Renew the coated surface.	Silicone Lubricant Instruction
Every 250,000 cycles	Coin Feeder	All	Exchange the Coin Path Insert.	Coin Feeder Path Insert

Cleaning the SMART Hopper

Baseplate Removal

Press the Latch on the SMART Hopper to release the SMART Coin System from the Baseplate and slide the SMART Coin System from the Baseplate.



Pressing the Front Latch

Press the Latch on the Coin Feeder to open the Lid of the Coin Feeder.



Pressing the Rear Latch

Press the Rear latch on the Coin Feeder rear to Remove the Coin Feeder from the SMART Hopper.



Detachment of the Coin Feeder

Move the Coin Feeder to the SMART Hopper back. Now move the Coin Feeder up.



Nozzle Removal

Move the Nozzle up until the Nozzle will release.



Remove the Front Panel

From the Top pull down and right (Twist) the Panel and the Panel clips off.



Cleaning of the Hopper

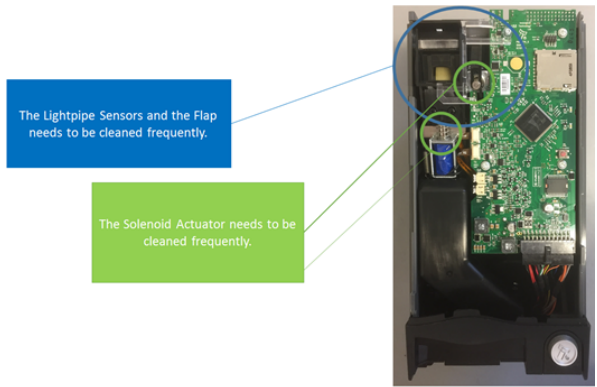

Silicone Lubricant Instruction

As soon as the Coin Feeder is cleaned as described in chapter Cleaning the SMART Coin System, it is required to renew the coated surface with Silicone Lubricant. This procedure is required every 50,000 coins to guarantee the best performance of the Coin Feeder.

The coated surface is required to prevent coins stick on the path and to prevent dirt and grease building up on the plastic path surface.

The recommended and tested Silicone Lubricant to renew the coated surface is Ambersil AMS4 Silicone Grease.

Coin Feeder Top Assembly

Apply the Silicone Lubricant only in the hatched areas shown in the drawing below:

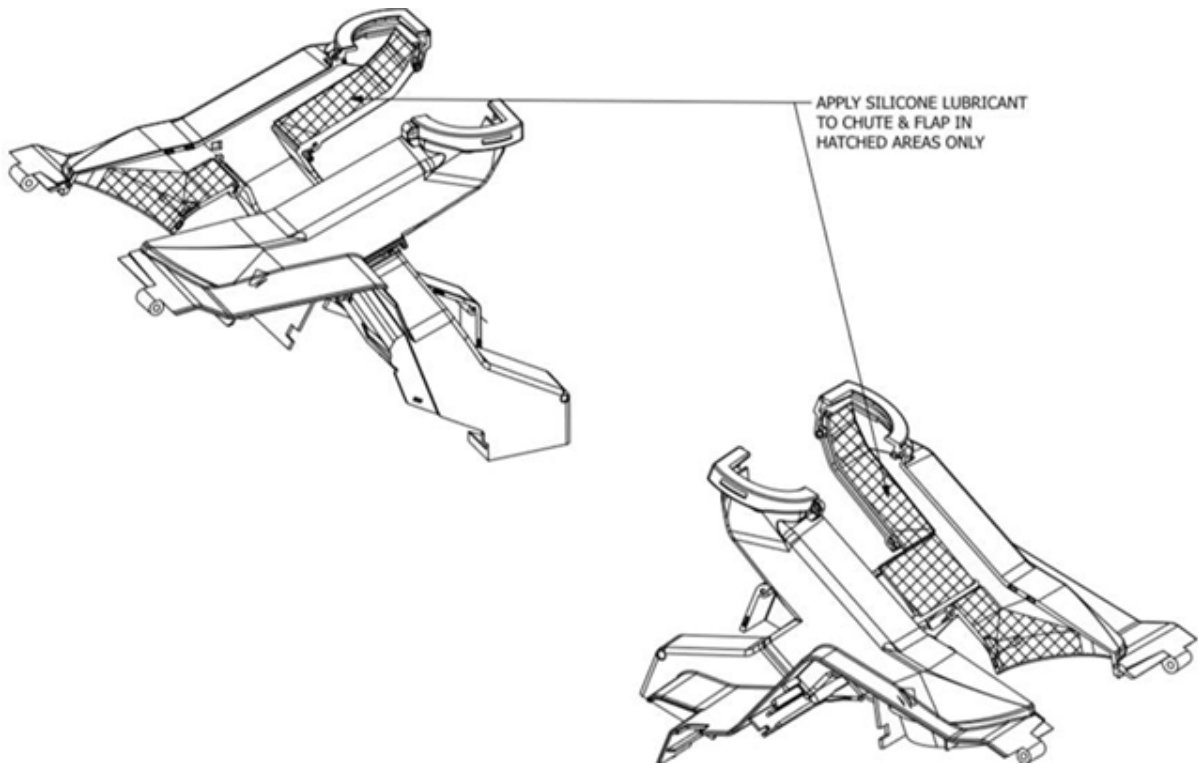

Apply Silicone Lubricant only in the hatched areas and do not disassemble the device to prevent a malfunction of the device.

Coin Feeder Base Assembly

Apply the Silicone Lubricant only in the hatched areas shown in the drawing below:

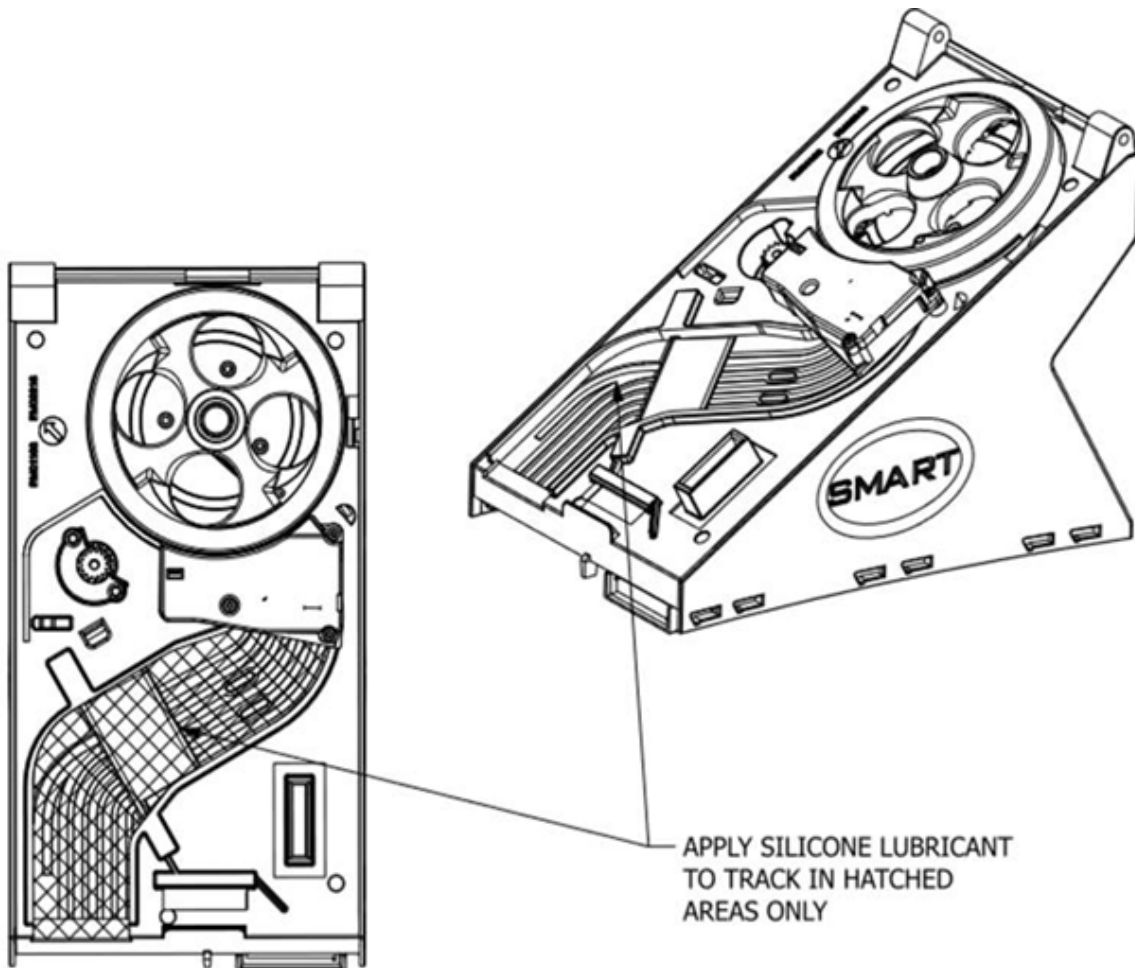

Apply Silicone Lubricant only in the hatched areas and do not disassemble the device to prevent a malfunction of the device.

Status LED Flash Codes SMART Coin System



Status Indicators		Status	Indicated Status / Error
Red	Green		
RED		Flashing Fast	In Bootloader
RED		Flashing Fast at Power Up	Calibrating
RED		Flashes x 2	Calibration Error
RED		Flashes x 3	Fraud Attempt
RED		Flashing Slow	Idle & Not Enabled (SSP)
RED	GREEN	Flashing Slow	Idle & Not Enabled (CC2)
RED	GREEN	Alternating Slow	DES Trusted Mode (CC2 DES Enabled)
	GREEN	Flashing Slow	Enabled

Status LED Flash Codes TWIN SMART Coin System

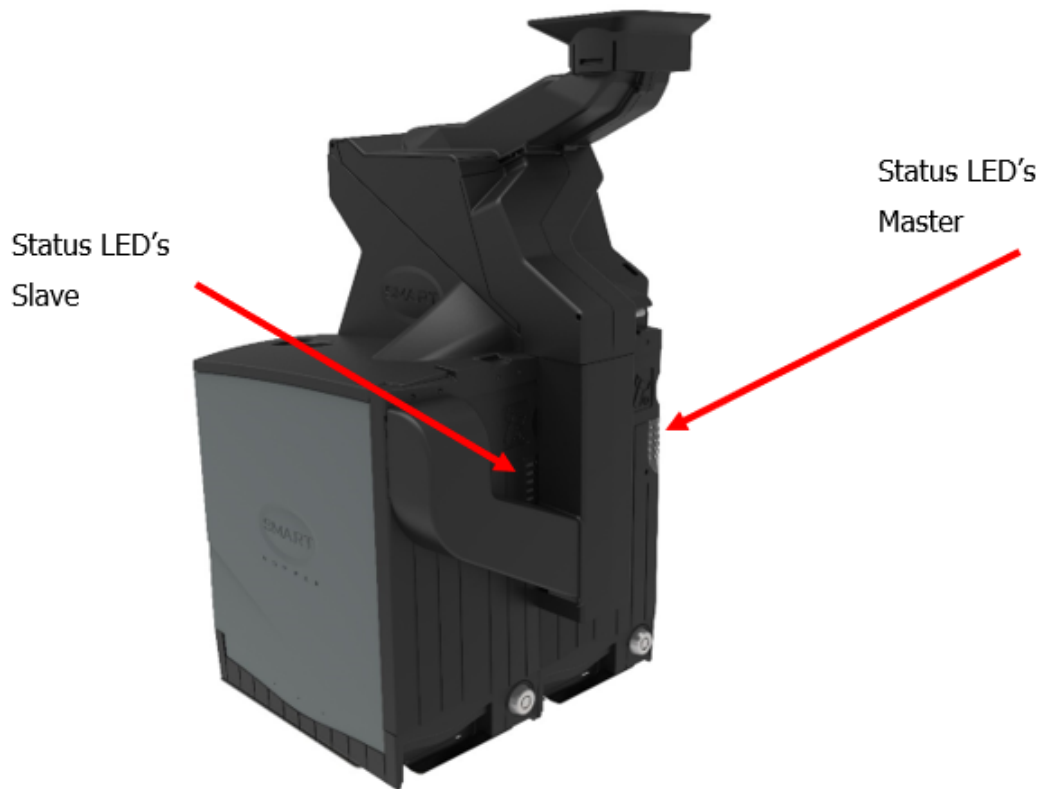

Status Indicators		Status	Indicated Status / Error
Red	Green		
RED		Flashing Fast	In Bootloader
RED		Flashing Fast at Power Up	Calibrating
RED		Flashes x 2	Calibration Error
RED		Flashes x 3	Fraud Attempt
RED		Flashing Slow	Idle & Not Enabled (SSP)
RED	GREEN	Flashing Slow	Idle & Not Enabled (CC2)
RED	GREEN	Alternating Slow	DES Trusted Mode (CC2 DES Enabled)
	GREEN	Flashing Slow	Enabled

Error LED Flash Codes

A summary of the Status Indicator Flash Codes for the SMART Coin System is shown below:

Status Indicators		Status	Description	Action
Red	Green			
	GREEN	Flashing 1Hz	Enabled	N/A
RED		1 Flash	Hopper Disabled	Host system to send enable command
RED		2 Flashes	Calibration Fault	Usually optical sensor contaminated. Operator to clean exit sensor light pipe. If fault persists, return to ITL for service. On TWIN SMART Coin System also the Link between the primary hopper and secondary hopper could be defective or missing.
RED		3 Flashes	Fraud Attempt Detected	Reset SCS. If this persists it indicates a problem with the top pay-out flap, light guide or exit sensor.
RED		4 Flashes	Feeder Calibration Error	Remove power and check the SMART Hopper and Coin Feeder connection. Persistent failure may require returning to ITL for service.
RED		5 Flashes	Not in Use	
RED		6 Flashes		
RED		7 Flashes	Dataset/Unit type mismatch	Re-download SCS Firmware. If this persists return to ITL for service.
RED		8 Flashes	Not in Use	
RED		9 Flashes		
RED		10 Flashes	Secondary Error (Twin Only)	Check secondary to primary connection.

Fault Finding Flow Chart

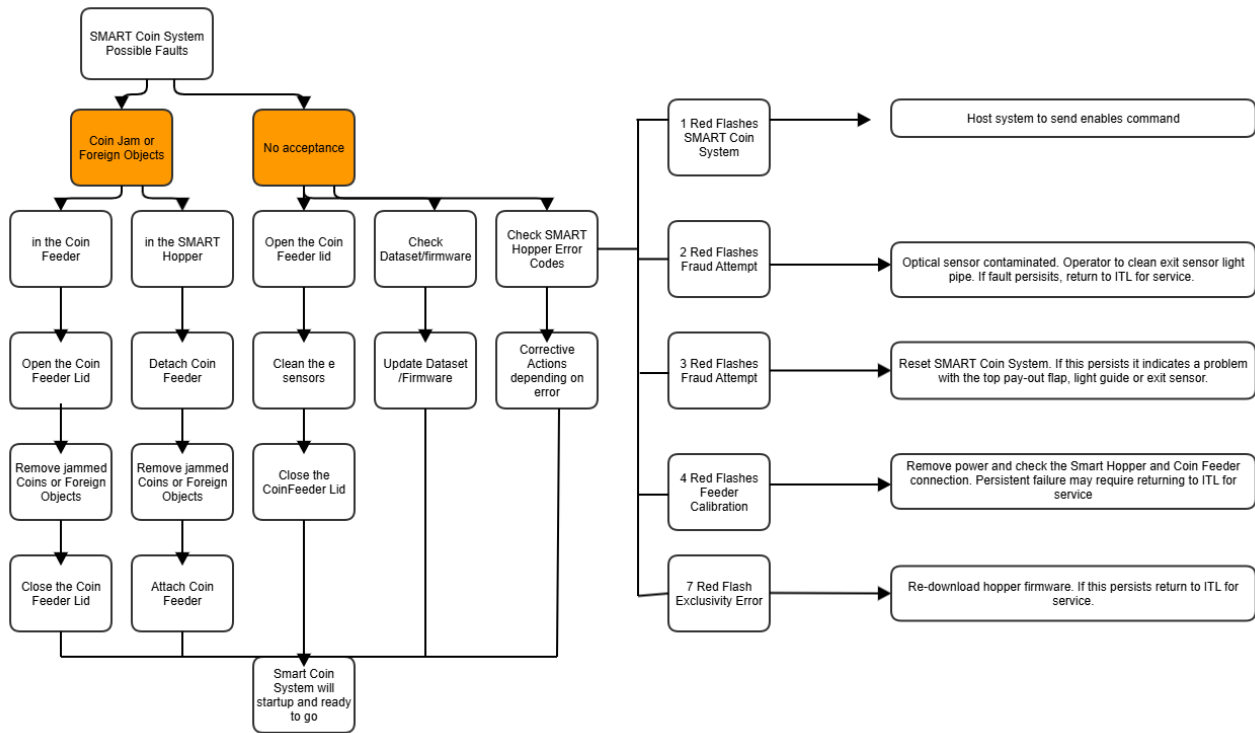

Troubleshooting via SD Card

General Description

Starting with firmware 1.21, a new SD Card function was added to the SMART Coin System and TWIN SMART Coin System firmware. This new function allows the user to gather unit information like dataset version, firmware version and the last 8 error codes.



Please note that the Secondary and the Primary data needs to be collected separately.

Hardware Requirements

Hardware Requirements

- Recommended SD-Card tested and verified by Innovative Technology LTD, Part Number IC02017
- A computer with a SD Card Reader

Data Collection

- Insert the prepared SD Card into the SD Card slot on the device
- Perform a Power Reset on the device
- Wait until the Setup Routine is finished (all motors stopped turning) and remove the SD Card from the SD Card slot

Analyse the SD Card Data

- Insert the SD Card into the SD Card Reader
- Open the SD Card content and the following data will be shown:

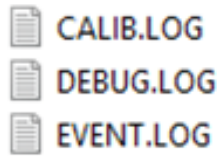

- CALIB.LOG consist of the latest Calibration Data of the Device
- DEBUG.LOG consist of the latest Debug information
- EVENT.LOG consist of the required data for the device troubleshooting
- Open the EVENT.LOG and you will see the following content:

```

01:55:03 01/01/80 -- Card inserted
00:00:00 01/01/80 -- Card inserted
00:00:00 01/01/80 -- SMART Coin System SH4
00:00:00 01/01/80 -- Firmware version : SH00041222435C01 1.
00:00:00 01/01/80 -- Dataset version : EUR05058
00:00:00 01/01/80 -- Hopper Serial: 4771816 Rev: 14 Type: E
00:00:00 01/01/80 -- Feeder Serial: 4813263 Rev: 14 Type: E 2.
00:00:00 01/01/80 -- Detector version: 0101
00:00:00 01/01/80 -- Validation Version: 3
00:00:00 01/01/80 -- Power on reset
00:00:00 01/01/80 -- System running at 24V
00:00:00 01/01/80 -- BOR off
00:00:00 01/01/80 -- RDP level 1
00:00:00 01/01/80 -- System codes: 2:18 2:18 2:18 2:18 2:18 2:18 2:18 2:18 3.
00:00:00 01/01/80 -- FeederCoins=3376 FeederRejects=34 FeederJams=0 HopperCoins=2766 HopperJams=0 CalFails=61 FraudAttempts=5 Resets=119 4.
00:00:00 01/01/80 -- Hopper Dataset Val: 3 Type: E
00:00:00 01/01/80 -- Feeder Dataset Val: 3 Type: E
00:00:00 01/01/80 -- Feeder Trigger Version : 1

```

1. Firmware and Dataset version of the device.
2. Serial and Hardware type of the device.
3. Last 8 device system error codes.
4. Statistic of the complete device (data is stored in the SMART Hopper, this means the Feeder statistic will not be reset if the Feeder is exchanged)

Interpreting System Error Codes

The following system error code types could be listed:

Number	Error Type
0	OK
1	POWER ON INIT
2	CALIBRATION ERROR PRIMARY SCS (if Twin Smart Coin System) or Smart Coin System
3	FRAUD ATTEMPT PRIMARY SCS (if Twin Smart Coin System) or Smart Coin System
4	PRIMARY – SECONDARY INTERFACE ERROR (if Twin Smart Coin System)
5	CALIBRATION ERROR SECONDARY HOPPER (if Twin Smart Coin System)
6	FRAUD ATTEMPT SECONDARY HOPPER (if Twin Smart Coin System)

Each of this error code types have sub error codes. A sub error code overview is shown below:

CALIBRATION_ERROR (2.xx and 5.xx)

ERROR TYPE 1st byte, 2 = Calibration Fault Primary 5 = Calibration Fault Secondary	ERROR CODE (2nd byte of the RX message)	DESCRIPTION	RECOMMENDED ACTION
2/5	1	The coin Pay-Out flap cannot be cleared at power on	Check for obstruction on the coin Pay-Out path
2/5	2	Hopper sensor could not be calibrated	Software reset
2/5	3	The hopper sensors cannot detect a free gap on the belt (could be something covering the coils in the path)	Software reset
2/5	4	Hopper sensor could not be calibrated	Software reset
2/5	5	Hopper sensor could not be calibrated	Software reset
2/5	6	Hopper sensor could not be calibrated	Software reset
2/5	7	The coin Pay-Out flap could not be calibrated	Check for obstruction in Hopper Pay-Out flap
2/5	8	The coin Pay-Out detection could not be calibrated	Check for obstruction in Hopper Pay-Out area
2	9	The feeder metal detector could not be calibrated	Software reset (check feeder connection)
2	10	There is something covering the coin path of the feeder that could not be cleared, right after leaving the motor disk	Check feeder for stuck coins in coin path
2	11	Feeder sensor could not be calibrated	Software reset (check feeder connection)
2	12	Feeder sensor could not be calibrated	Software reset (check feeder connection)

ERROR TYPE 1st byte, 2 = Calibration Fault Primary 5 = Calibration Fault Secondary	ERROR CODE (2nd byte of the RX message)	DESCRIPTION	RECOMMENDED ACTION
2	13	Feeder sensor could not be calibrated	Software reset (check feeder connection)
2	14	Feeder sensor could not be calibrated	Software reset (check feeder connection)
2	15	Feeder sensor could not be calibrated	Software reset (check feeder connection)
2	16	Lateral output sensor of Feeder could not be calibrated	Check for obstruction in the feeder lateral path
2	17	Accept Pay-Out sensor of Feeder could not be calibrated	Check for obstruction in the feeder main path and flap
2/5	18	PSU voltage out of range	Check PSU voltage
2	19	Pay-In Flap of Feeder not in correct position	Check for obstruction in the feeder main path and flaps
2/5	20	Unknown coins remain in the hopper after an Empty	Remove the unknown coins before continuing
2	21	Internal Hopper-Feeder comms failed	Software reset (check feeder connection)
2	22	Not in use	
2	23	Pay-In Flap of Feeder not in correct position	Check for obstruction in the feeder main path and flaps
2	24	Twin Secondary Calibration Fault	Check the secondary device for Calibration error.
2	25	Feeder Path Jam	Remove all coins / debris from the coin path of the feeder.

ERROR TYPE 1st byte, 2 = Calibration Fault Primary 5 = Calibration Fault Secondary	ERROR CODE (2nd byte of the RX message)	DESCRIPTION	RECOMMENDED ACTION
2	26	FEEDER MOTOR FAULT	Software reset
2	27	Feeder Accept Sensor in Twin mode get covered for too long when accepting coins or while unit is idle and feeder is enabled	Software reset
2	28	Feeder Lateral Sensor in Twin mode get covered for too long when accepting coins or while unit is idle and feeder is enabled	Software reset

FRAUD_ATTEMPT (3.xx and 6.xx)

ERROR TYPE 1st byte, 3 = Fraud attempt Primary 6 = Fraud attempt Secondary	ERROR CODE (2nd byte of the RX message)	DESCRIPTION	RECOMMENDED ACTION
3/6	1	During Pay-Out related activity, the hopper Pay-Out flap was active when it should not	Reset SCS. If this persists it indicates a hardware problem.
3/6	2	During Pay-Out related activity, the hopper Pay-Out opto was active when it should not	Reset SCS. If this persists it indicates a hardware problem.
3/6	3/4/5/6/7/8	Not in Use	
3/6	9	During idle (unit should be enabled), the hopper Pay-Out flap was active when it should not	Reset SCS. If this persists it indicates a hardware problem.
3/6	10	During idle (unit should be enabled), the hopper Pay-Out opto was active when it should not	Reset SCS. If this persists it indicates a hardware problem.

ERROR TYPE 1st byte, 3 = Fraud attempt Primary 6 = Fraud attempt Secondary	ERROR CODE (2nd byte of the RX message)	DESCRIPTION	RECOMMENDED ACTION
3/6	11	Not in Use	
3/6	12	Unit ID not matching the dataset	Re-download the correct dataset/firmware.
3/6	13	Unit ID not matching the device type	Connect suitable hardware types.
3	14	Fraud Attempt on Secondary Hopper	
3	15	Feeder mismatch - a single feeder is attached to a hopper that is set to twin mode	Check if a Twin Coin Feeder is mounted on the TWIN SMART Coin System or the correct mode set

Primary-Secondary Interface Error (4.xx)

ERROR TYPE 1 st byte, 4 = Twin interface	ERROR CODE (2nd byte of the RX message)	DESCRIPTION	RECOMMENDED ACTION
4	1/2/5/8/9/10/11/12	Comms fault in the Primary-Secondary interface	Software reset, check the primary-secondary interface cable, check the secondary comms configuration
4	3	FW version of secondary is different to the primary	Check the FW version of the secondary device
4	4	Dataset version of secondary is different to the primary	Check the dataset version of the primary device
4	6/7	Not in Use	

Clearing a Jam

Clearing a Jam from the Coin Feeder

 Before attempting to clear the Jam you must ensure the power has been removed.

- 1 Empty all coins from the funnel.
- 2 Lift the catch on the front of the feeder and lift the lid back.
- 3 Clear the jammed coin from the disk and ensure it is free to rotate.
- 4 Wipe the track of any coin dust.
- 5 Ensure the diverter flap is able to move, the flap should be capable of opening onto the coin path.
- 6 Once all of the coins have been cleared ensure the drive gear isn't impeded.
- 7 Close the lid of the feeder and reapply power.
- 8 Check for normal operation.

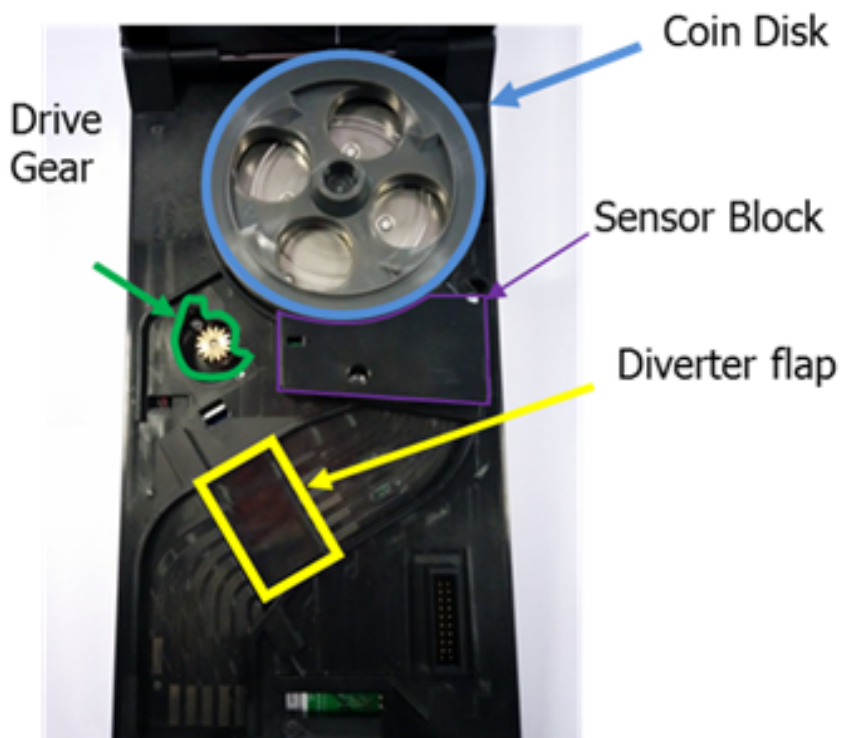

 Removing the sensor block will require returning to a service center for re-initialisation.

Clearing a Jam from the Hopper

1 Base Plate Removal

Press the Latch on the SMART Hopper to release the SMART Coin System from the Baseplate and slide the SMART Coin System from the Baseplate.



2 Pressing the Front Latch

Press the Latch on the Coin Feeder to open the Lid of the Coin Feeder.



3 Pressing the Rear Latch

Press the Rear latch on the Coin Feeder rear to Remove the Coin Feeder from the SMART Hopper.



4 Detachment of the Coin Feeder

Move the Coin Feeder to the SMART Hopper back.
Now move the Coin Feeder up.



5 Empty the Coin Bowl

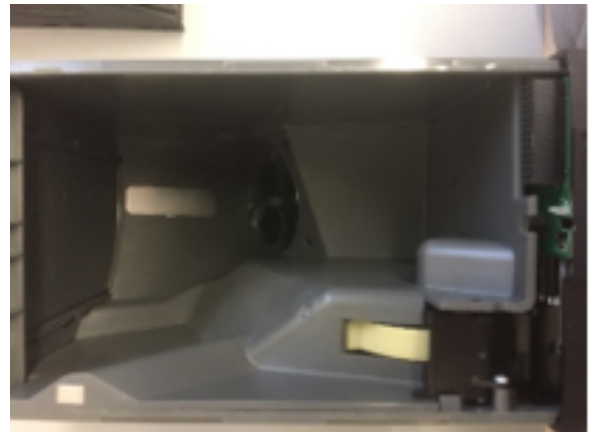

Empty all Coins from the Coin bowl.



6 Clear the Jam

Turn the Disc anti-clockwise but be cautious to avoid harm.



<p>7 Coin Drop</p> <p>While turning the disc the coins will drop out here.</p>	
<p>8 Back to Operation</p> <p>Attach the Coin Feeder and slide the SMART Coin System on the Baseplate.</p>	

Checking Power Connections

<p>1 Power Cable</p> <p>Check if the Power Cable is correctly fitted</p>	
<p>2 Power Specification</p> <p>Check if the Power supply meets the specification from Power Requirements.</p>	

Checking Communication Connections

<p>1 Communication Cable</p> <p>Check if the Communication Cable is correctly fitted</p>	
<p>2 Interface Specification</p> <p>Check if the Communication Cable and Machine Setup meets the specification from Protocols and Interfacing</p>	

Checking the Primary and Secondary Link

Check if the Primary and Secondary Link is correctly fitted.



Cleaning the SMART Coin System

Cleaning the Coin Feeder

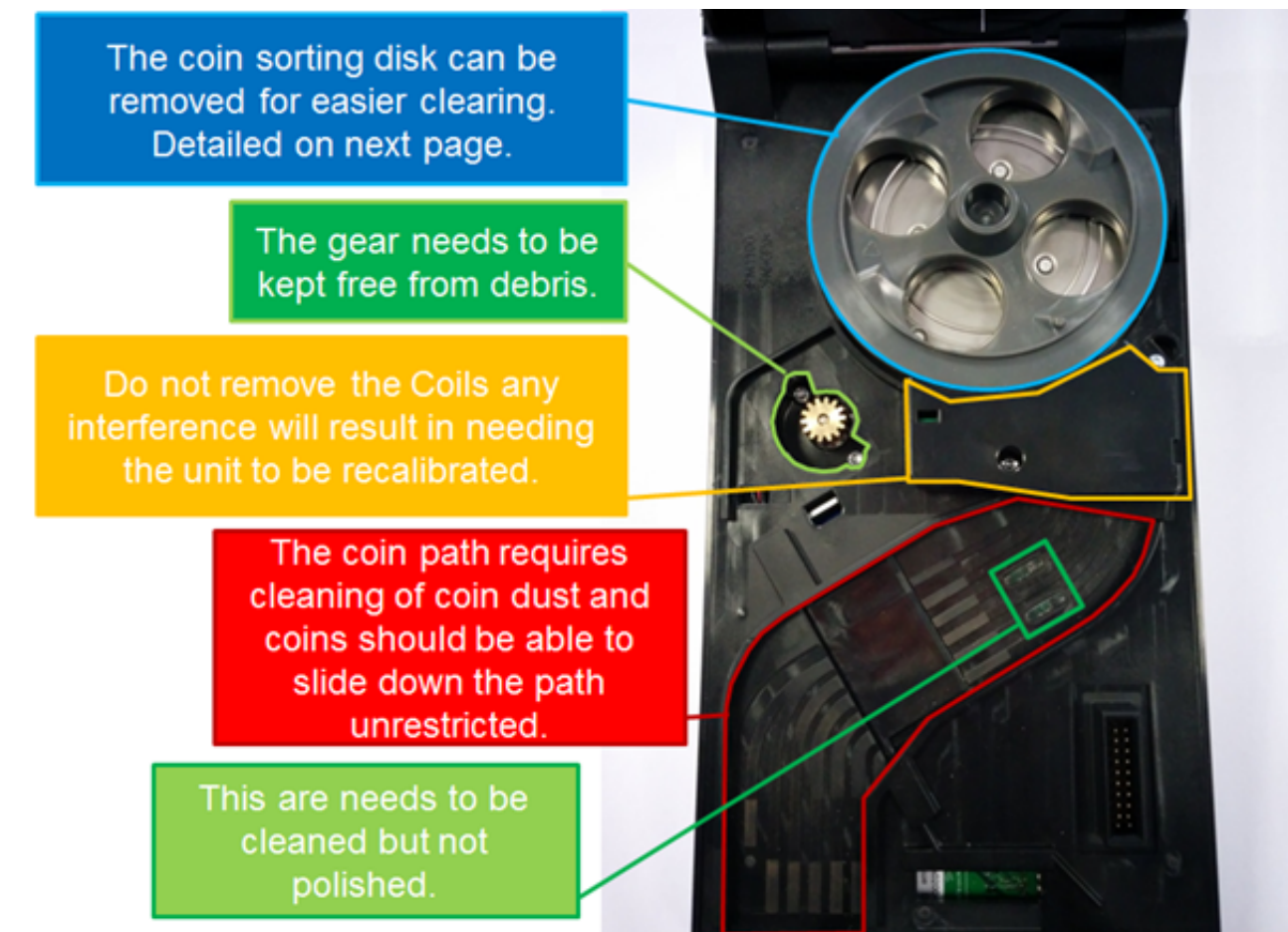



- Do not use solvent based cleaners such as alcohol, petrol, methylated spirits, white spirit or PCB cleaner. This will result in permanent damage to the SMART Coin System, only use a mild detergent.

An overview of all recommended Cleaning and Maintenance Intervals/Tasks can be found in [Recommended Cleaning Intervals](#).

Disk Removal

If required, the coin sorting disk can be removed for cleaning and removal of debris which may be trapped under the disk.

- Please ensure the power has been disconnected before attempting to remove the coin sorting disk.

<p>1 To remove the disk, the screw highlighted needs to be removed. A T30 Screwdriver will be required.</p> <div data-bbox="226 212 823 322" style="border: 1px solid black; padding: 5px; background-color: #e6f2ff;"> <p>i Once removed the screw will be held captive inside the hole.</p> </div>	
<p>2 Open the Smart Coin System using the catch on the front of the Feeder.</p>	
<p>3 After cleaning the disk, the screw requires a small amount of thread locking or stud lock glue is required on the end of the screw and then must be screwed back in to place tightly. Screw Torque Setting 0.60N/m +5%.</p>	

Coin Feeder Path Insert Exchange Instruction

Innovative Technology Ltd has a policy of continuous product improvement. As a result, the SMART Coin System Range have on the latest Revision an exchangeable Coin Path Insert. This Coin Path Insert is used in the area of the Coin Feeder where the coin path is usually most worn. The exchange of this part is required every 250,000 coins to guarantee the best performance of the Coin Feeder. If the below described procedure is followed, no re-initialization of the Coin Feeder is required.

1

Pressing the Front Latch

Press the Latch on the Coin Feeder to open the Lid of the Coin Feeder.



2

Lift the Lid

Lift the Lid of the Coin Feeder back to the End Position.



3

Sensor Box Removal

Unscrew the 2 Screws which fix the Sensor Box and Lift the Sensor Box up.

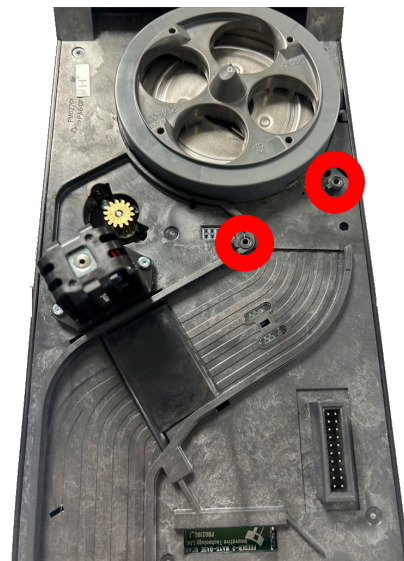

4 Remove the Coin Feeder Path Insert

Lift up the Coin Feeder Path Insert with a flat screwdriver at the marked position.



5 Cleaning the Coin Path

This area can now be cleaned but not polished.

ⓘ Do not use solvent based cleaners such as alcohol, petrol, methylated spirits, white spirit or PCB cleaner. This will result in permanent damage to the SMART Coin System, only use a mild detergent.



6 Add the new Coin Feeder Path Insert

Clip in the new Coin Feeder Path Insert.



7 Add the Sensor Box back to the original position

Add the Sensor Box back to the original position and screw on the two screws at the marked position.

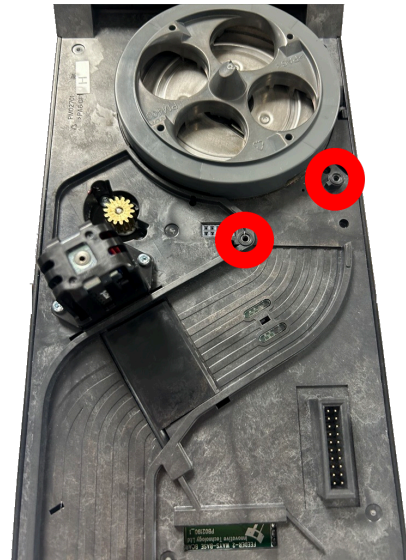

Coin Feeder Path Insert Part Numbers

SMART Coin System Coin Feeder

Hardware Type	Path Insert Part Number
Type A	no Insert in current Revision
Type C	no Insert in current Revision
Type D	no Insert in current Revision
Type E	PM03265
Type F	PM03278
Type G	PM03265
Type H	PM03386

TWIN SMART Coin System Coin Feeder

Hardware Type	Path Insert Part Number
Type E	PM03265
Type F	PM03278
Type G	PM03265
Type H	PM03386

SMART Coin System Range Product Compliance



EC Declaration of Conformity

- CE
- UKCA
- FCC
- UL
- IEC CB
- RoHS
- REACH

For full details on product compliance and to download certificates, please visit the [SMART Coin System Range Support Hub](#) page.

WEEE



The European Union's directive 2002/96/EC on Waste Electrical and Electronic Equipment (WEEE) was adopted by the European Council and Parliament in 2003 with a view to improving the collection and recycling of Waste Electrical and Electronic Equipment throughout the EU, and to reduce the level of non-recycled waste. The directive was implemented into law by many EU member states during 2005 and 2006. Products and packaging that display the symbol (shown left) indicates that this product must NOT be disposed of with other waste. Instead it is the user's responsibility to dispose of their Waste Electrical and Electronic Equipment by handing it over to an approved re-processor, or by returning it to the original equipment manufacturer for reprocessing.

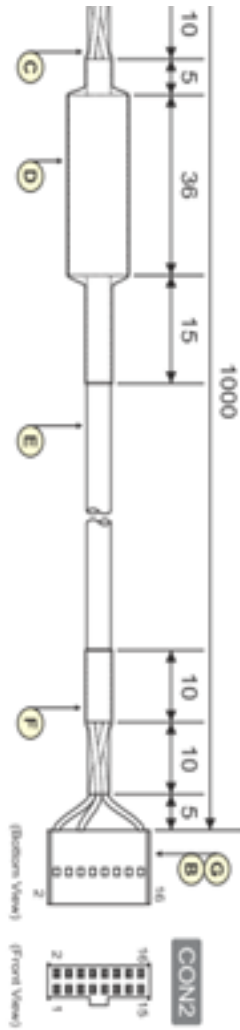

QTY Description

QTY	Description	Vendor
1	90142-00008 housing (2x8way 2.54mm pitch with key)	Molex
1	9733272 tin plated crimp	Molex
1	60mm long, black heat shrink sleeve	-
1	KSA RH 14.2x6.35x36 sleeve core (Single turn)	Paddiford Electronics/Z.Shen Enterprise
1	4-core AWM style 2462 24AWG cable	-
1	20mm long, black heat shrink sleeve	-
1	90142-00116 housing (2x8way 2.54mm pitch with key)	Molex

Pin	Gauge (AWG)	Colour	Comments
16	24	Black	Commns_GND
1	24	Orange	Wend_1 (SSP_TX)
5	24	Brown	Inhibit_1 (SSP_RX)

1) and Pin15 (CON2) are fitted with crimps but not connected as are unloaded

Not to be used for all smart UK-UK-VWV
 Drawings must be read to UK-UK-VWV

2009 © Copyright of Innovative Technology Ltd

NOT TO SCALE
 All dimensions in mm ±2mm

SSP Smart Hopper User Interface cable assembly (discrete wires)

All Materials used must be RoHS Compliant

Part No: P Newton
 Date: 09/04/09
 Drawn By: [Blank]
 Check By: [Blank]
 Date: [Blank]

CN00398 - Dual eSSP Interface

CN398 2

Parts List

Item	QTY	Description	Vendor	Connectivity	CON1 Pin	CON2 Pin	CON3 Pin	CON4 Pin	CON5 Pin	Gauge (AWG)	Colour	Comments
A	1	0039012165 housing (2x8way 4.2mm pitch Mini-Fit receptacle)	Molex	16	7	-	-	1	1	24	Orange	SSP TX (Vend1)
B	4	0039000038 tin plated, female crimp (2x8way 4.2mm pitch Mini-Fit receptacle)	Molex	14	8	-	-	5	5	24	Brown	SSP RX (Inhibit1)
C	1	742700752 toroidal core (GODD)emmx ID8mmxL10mm) (2 turns (1 loop); cable tie to secure in place)	Würth Electronics	9	-	-	1	-	-	22	Red	V_IN (12V)
D	10	15mm long, black heat shrink sleeve (spread along the length of harness with typical separation of 82mm)	-	1	2	1	-	16	16	24/22	Black	GND
E	2	Standard 22AWG wire	-	-	-	-	-	-	-	-	-	-
F	1	553-0100-01 stackable black 4mm banana plug	Deltron	-	-	-	-	-	-	-	-	-
G	1	553-0500-01 stackable red 4mm banana plug	Deltron	-	-	-	-	-	-	-	-	-
H	2	4-core AWM style 2462 24AWG cable	-	-	-	-	-	-	-	-	-	-
I	1	25mm long, black heat shrink sleeve	-	-	-	-	-	-	-	-	-	-
J	1	90142-0008 housing (2x4way 2.54mm pitch with key)	Molex	-	-	-	-	-	-	-	-	-
K	8	9733272 tin plated crimp	Molex	-	-	-	-	-	-	-	-	-
L	1	90142-0016 housing (2x8way 2.54mm pitch with key)	Molex	-	-	-	-	-	-	-	-	-

Comments

- CON1 mates with 6745-2160 straight header (on Smart Payout)
- CON2 connects to SSP Hopper Interface Port
- CON3 connects to V- (GND) of power supply
- CON4 connects to V+ (12V) of power supply
- CON5 connects to Host Machine

Note:

- Pin 14 and 16 (CON1) each has two wires crimped together.
- Pin 1 (CON1) has three wires crimped together. If crimp is unable to hold three wires together please use AWG 26 for the 4-core PVC cable.
- Pin 1 (CON2) is fitted with crimp but not connected.
- Pin 15 (CON5) is fitted with crimp but not connected.
- All other pins are unloaded.
- For the unused wire in the 4-core PVC cable, please trim excess or, if possible, please use a 3-core PVC cable.
- Length for both PVC cable is the same

Host machine (via CON5) controls both Hopper and Payout through different SSP addresses. Hence, SSP_TXD_(Vend1) on Payout and SSP_TX on Hopper are both linked to pin 1 (Vend1) on CON5.

Connectivity

CON1 Pin	CON2 Pin	CON3 Pin	CON4 Pin	CON5 Pin
16	7	-	-	1
14	8	-	-	5
9	-	-	1	-
1	2	1	-	16

Pinout Details:

- CON2 (Top View):** Pin 1 (Orange), Pin 2 (Brown), Pin 7 (Red), Pin 8 (Black)
- CON5 (Front View):** Pin 1 (Orange), Pin 2 (Brown), Pin 15 (Red), Pin 16 (Black)

Dimensions:

- CON1 to CON3: 40mm
- CON3 to CON4: 890mm
- CON4 to CON5: 1000mm
- CON1 to CON5: 920mm
- CON1 to CON2: 15mm
- CON2 to CON3: 10mm
- CON3 to CON4: 15mm
- CON4 to CON5: 15mm

CN00389 - Hopper Interface Power Cable

CN389 3

1000 mm

Parts List

Item	QTY	Description	Part Number	Vendor
A	1	4mm Stackable Plug, Red	553-0500-01	Deltron
B	1	4mm Stackable Plug, Black	553-0100-01	Deltron
C	1	Polarised Audio Wire, 2 x 0.5mm ² AWG, 20-18	-	-
D	1	4 Circuit Receptacle Housing, 4.2mm PE Series UL94V-1	794954-4	Tyco
E	2	4.2mm PE Series Crimp Socket (Not Shown)	1586315-1	Tyco

Connectivity

CON1	CON2	CON3	Colour	Comments
Pin 1	Pin 1	Pin 1	Black/Red	24V (Hopper Power)
Pin 2	Pin 2	Pin 2	Black	0V (Hopper GND)

Note:
All other pin locations are empty.
Audio wire colour is not important but polarisation marking is required.

All parts must be rated to at least UL349/VW1.
All connector housings must be rated to UL94V-0.
2009© Copyright of Innovative Technology Ltd
All dimensions in mm 227mm
NOT TO SCALE
All dimensions in mm 227mm
Hopper Interface Power Cable
P. Newton
14/05/2009
All Materials used must be RoHS Compliant

CN00496 - Hopper to RM5 Coin Mech Cable Assembly

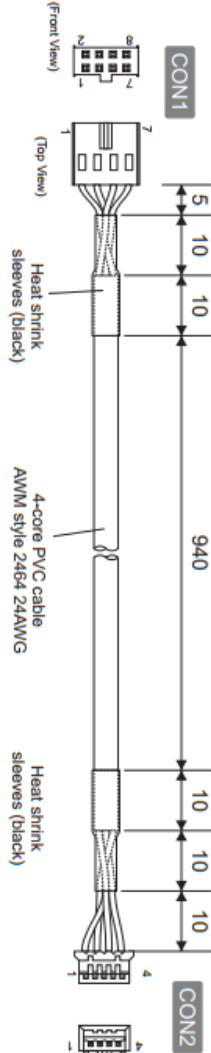

Terminal
 CON1 Molex 90142-0008 (2x4way 2.54mm pitch with key)
 CON2 JST XHP-4 Connector Housing, 4 Way

Crimp
 9733272 (tin plated)
 BXH-001T-P0.6 28-22AWG

Connectivity by conductor

CON1	CON2	Gauge (AWG)	Colour	Comments
Pin 1	Pin 1	24	Red	+12VDC
Pin 2	Pin 3	24	Black	GND
Pin 7	Pin 4	24	Orange	Data (CCT_TX)

Note: Pins not named are unloaded

Comments
 CON1 is connected to the Hopper base plate in the slot that says 'Coin Mech'.

All parts must be rated to at least UL94-VW1		2009 © Copyright of Innovative Technology Ltd		TITLE		Hopper to RM5 Coin Mech Cable Assembly		DATE		20/04/2012		CHECKED BY		DATE		MATERIAL		FINISH	
All connector housings must be rated to UL94-V0		ROBSON'S TECHNOLOGIES LIMITED		Innovative Technology Ltd		NOT TO SCALE		All dimensions in mm ±27mm		DESIGNED BY		PNewton		DATE		All Materials used must be RoHS Compliant		-	
ROBSON'S TECHNOLOGIES LIMITED		ROBSON'S TECHNOLOGIES LIMITED		ROBSON'S TECHNOLOGIES LIMITED		ROBSON'S TECHNOLOGIES LIMITED		ROBSON'S TECHNOLOGIES LIMITED		ROBSON'S TECHNOLOGIES LIMITED		ROBSON'S TECHNOLOGIES LIMITED		ROBSON'S TECHNOLOGIES LIMITED		ROBSON'S TECHNOLOGIES LIMITED		ROBSON'S TECHNOLOGIES LIMITED	
SCALE NO.	MOD NO.	DATE	MOD BY	SCALE NO.	MOD NO.	DATE	MOD BY	SCALE NO.	MOD NO.	DATE	MOD BY	SCALE NO.	MOD NO.	DATE	MOD BY	SCALE NO.	MOD NO.	DATE	MOD BY
A	B	C	D	E	F	G	H	I	J	K	L	M	N	O	P	Q	R	S	T

WR02274 - RS232 to TTL Converter SCS Cable Assembly

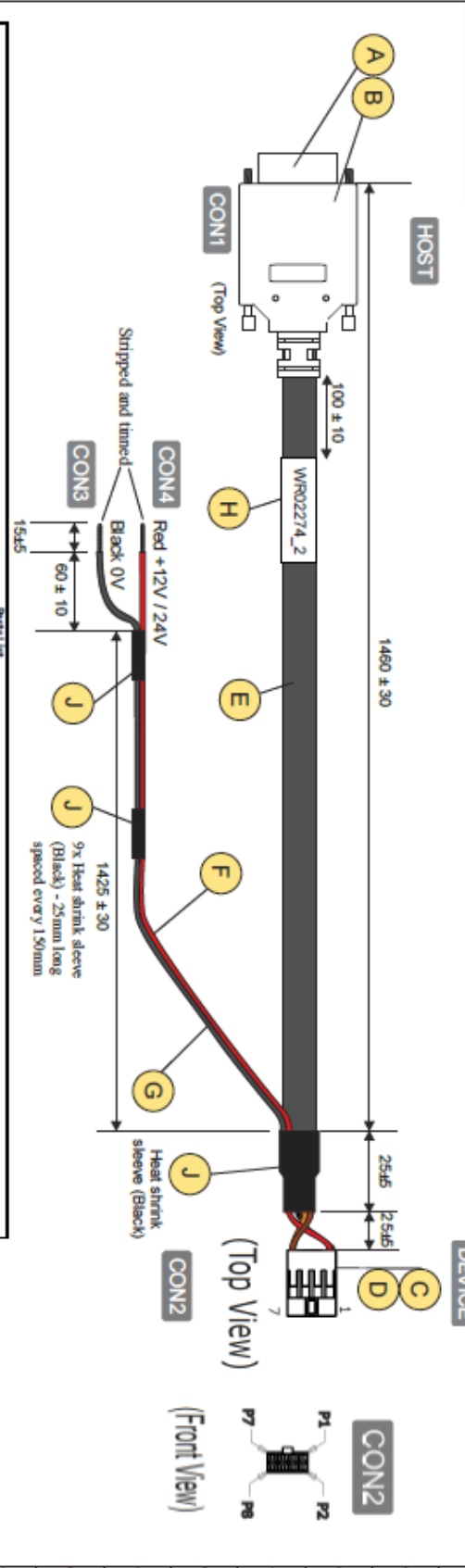

Item	Qty	Description	Part List	Vendor or Part Num Ref	Comments
A	1	RS232 (9-way D-sub) to 5V TTL Converter Module 315,500 mini and rate 3.272kV supply input			Alternative may be used, ITI Approval must be granted prior to production
B	1	PVC Black Over Mould for USB			Alternative may be used, ITI Approval must be granted prior to production
C	8	20-24AWG Crimp Terminal, 17x (5x)		90119-0109	Alternative may be used, ITI Approval must be granted prior to production
D	1	Housing (8 Way 254mm pitch, polarized)		90142-0008	Alternative may be used, ITI Approval must be granted prior to production
E	1	4 core AWG18 Style UL 2460 24AWG Cable			Alternative may be used, ITI Approval must be granted prior to production
F	1	Red Cable rated to UL1061 - 24AWG			Alternative may be used, ITI Approval must be granted prior to production
G	1	Black Cable rated to UL1061 - 24AWG			Alternative may be used, ITI Approval must be granted prior to production
H	1	10mm x 10mm white heat shrink sleeve, preforming constant = 460 (274_2)			Alternative may be used, ITI Approval must be granted prior to production
I	1	30x25mm Heat Shrink			Alternative may be used, ITI Approval must be granted prior to production
J	10				

Connectivity					
CONN1	CONN2	CONN3	CONN4	Gauge	Colour
P18	P7H	P18	P18	AWG	
7*	8	-	-	24	Orange
7*	7	-	-	24	Brown
7*SD*	21(DG)	1	-	24	Black
7*AV*	1(DG)	-	1	24	Red
SHIELD*	-	-	-	Shield	Shield only connected internally to CON1

Notes:
 1. DC - Double Connection Point
 2. Load/Crimp into all empty locations on CON2
 3. CON1 pinout should be the same as shown in Figure 1.



Figure 1 - Internal to CON1

Note to Manufacturers
 Details are required for all components showing evidence of UL compliance
 RoHS compliance | UL 94-V0 rated (connector housing) | UL1591 VWI rated (all other parts)
 All dimensions are in mm | Tolerance is ± 0.5mm, unless specified

RS232 TO TTL CABLE - 8 WAY FOR SCS

Rev	By	App'd	Chg'd	Chg'd By	Chg'd Date	Reason
1						
2						

Ensure there is space for coins to fall clear.

Label Description

SMART Hopper

The image shows a label for the SMART Coin System Range. The label is black with white and orange text. It contains the following information:

- SMART COIN SYSTEM RANGE**
- POWER SUPPLY REQUIREMENTS**
 - SMART HOPPER 24V DC 3A (6.5A MAX)
 - SMART COIN SYSTEM 24V DC 3A (7A MAX)
 - TWIN SMART COIN SYSTEM 24V DC 6A (13A MAX)
- LED Flash Codes**
 - RED LED flashing fast (at power up) - Calibrating
 - GREEN LED flashing slow (enabled) - Enabled
 - RED LED (2 flashes) - Calibration error
 - RED LED (3 flashes) - Fraud attempt
 - RED LED flashing slow (every second) (SSP mode) - Idle not enabled
- WARNING**
 - Moving parts can cause injury. Ensure lid in place whilst power is applied.
- Serial No**: UKS3619174
- Year / Week**: 2015/12
- TYPE: A**
- Revision: 5**
- Coin Dataset**: EUR05023
- Firmware**: SH0004111000C03
- Dataset Version**: (indicated by a callout)

Callouts on the right side of the label provide further details:

- Power Requirements**: Please refer to chapter [9.4 Power Requirements](#).
- LED Flash Codes**: Please refer to chapter [7 First Level Support](#).
- Production Date**: This is the Production Date (Week and Year) of the unit.
- Serial Number**: This is the Serial Number of the unit.
- Hardware Type**: This is the Hardware Type of the unit. Please refer to chapter [9.7 Media Requirements](#).
- Hardware Revision**: This is the Hardware Revision of the unit.
- Firmware Version**: This is the Firmware Version of the unit, which was programmed at delivery.
- Dataset Version**: This is the dataset Version of the unit, which was programmed at delivery.

At the bottom of the label, it says **Innovative Technology** with the website www.innovative-technology.com and the code LB02181-1.

Coin Feeder

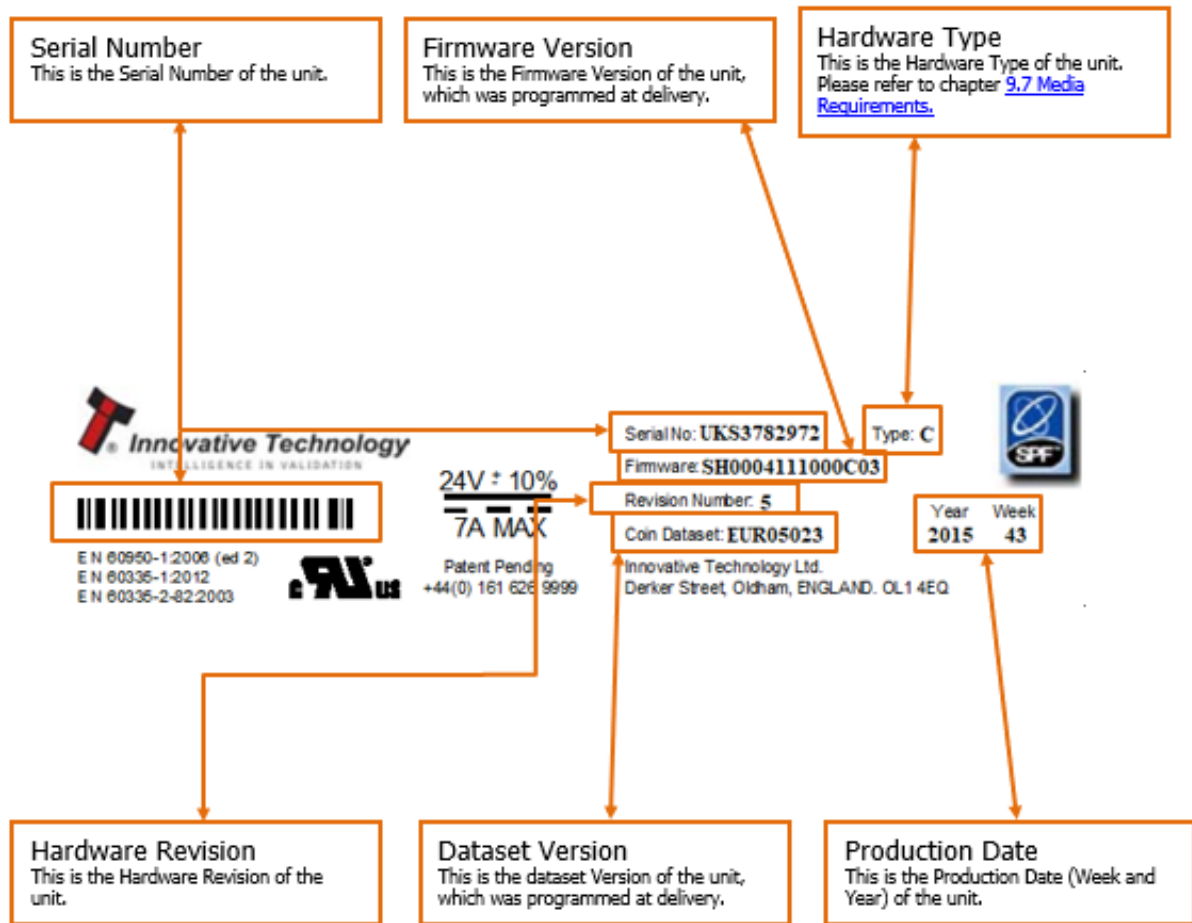

Configuration Button Functions

Action	Power Status	Function	Location of the function button
Press the button, then press the button again within 5 seconds (do not double click, a pause of 2 sec in press is required)	Powered ON	Switches interface between SSP and CC2. FW <1.32	
Press and hold for 5 seconds	Powered ON	Switches interface between SSP and CC2. FW ≥1.32	
Two short presses of the button (double tap)	Powered ON	Will show the current protocol in use by flashing the red LED (1 for SSP, 2 for CC2). FW ≥1.32	
Press and hold for longer than 5 seconds	Powered ON	Switch between USB mode with FW <1.25 (CDE & HID)	

Action	Power Status	Function	Location of the function button
Press and hold for 10 seconds	Powered ON	Switch between USB mode with FW ≥ 1.25 (CDE & HID)	

File Naming Convention

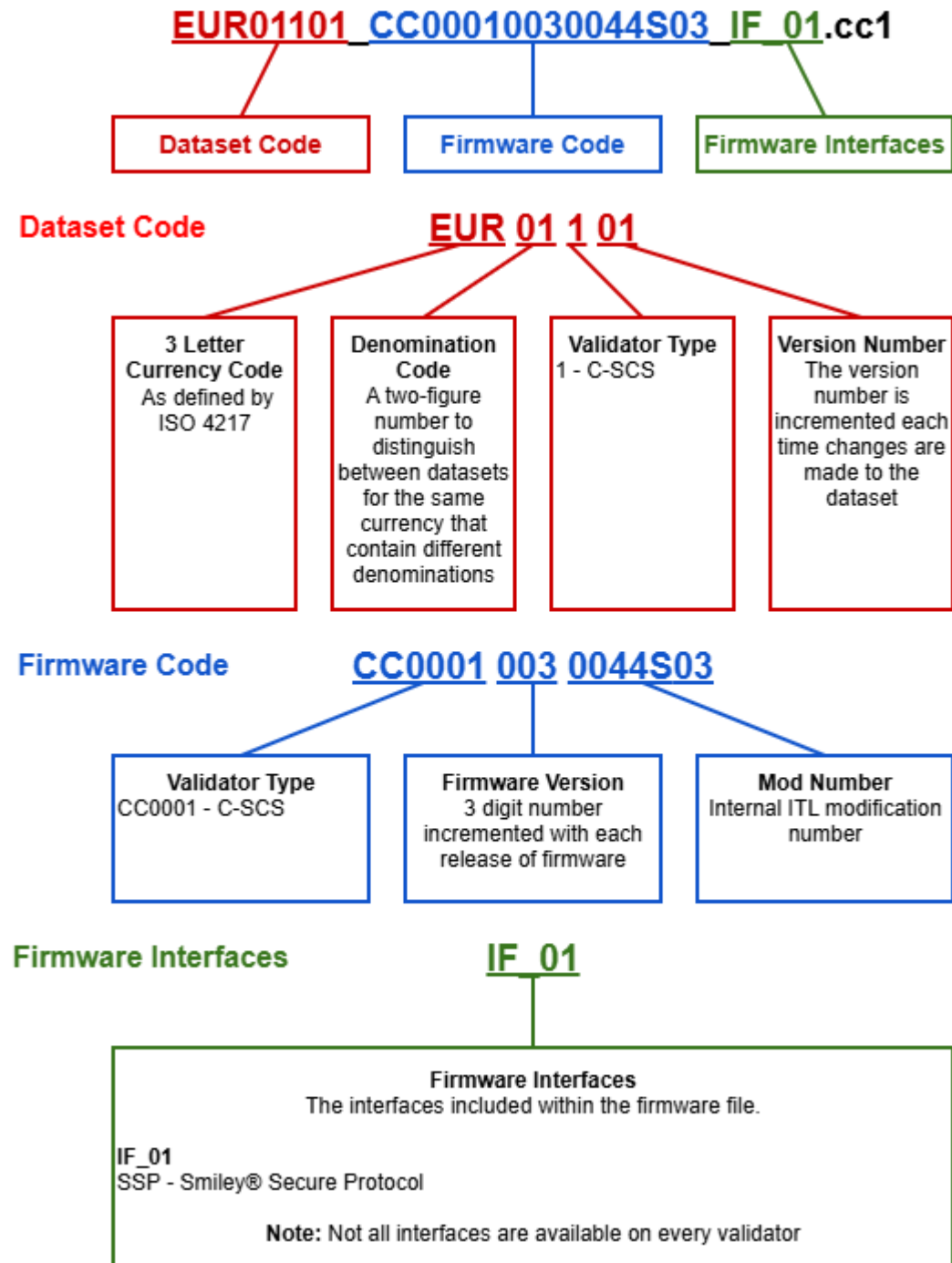

Energy Profiles SMART Coin System

Idle

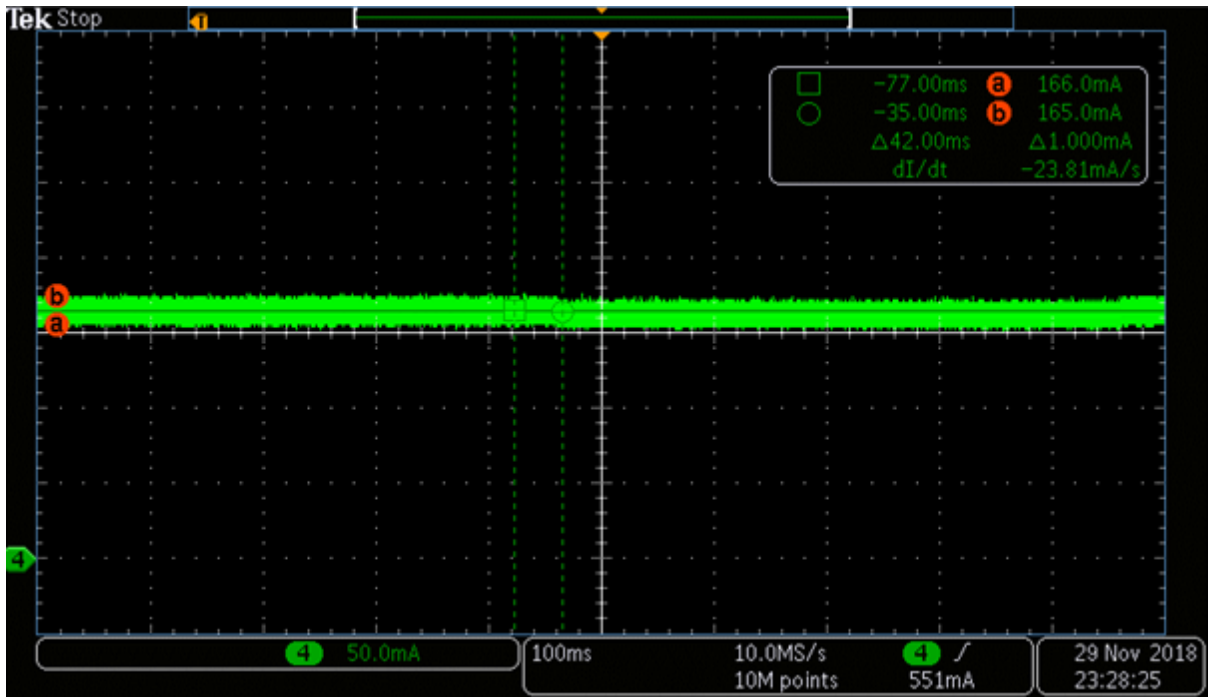

Peak: **170mA**

Power Up

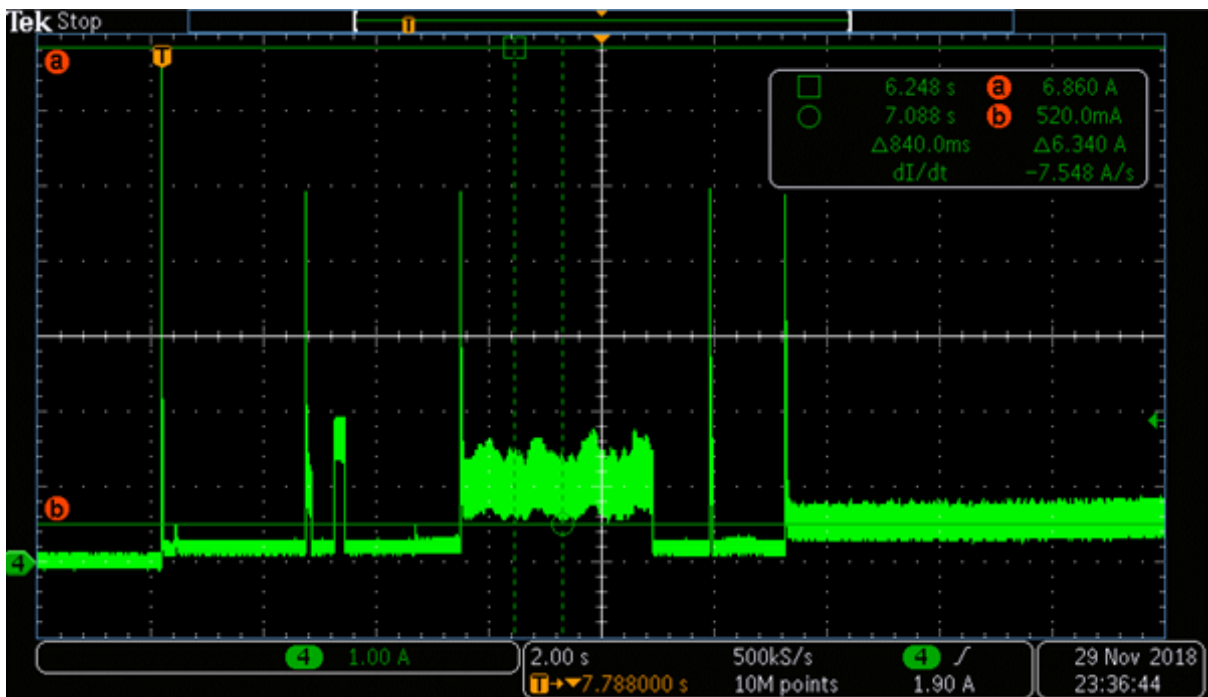

Peak: **6.86A**

Pay In (\$3.82)

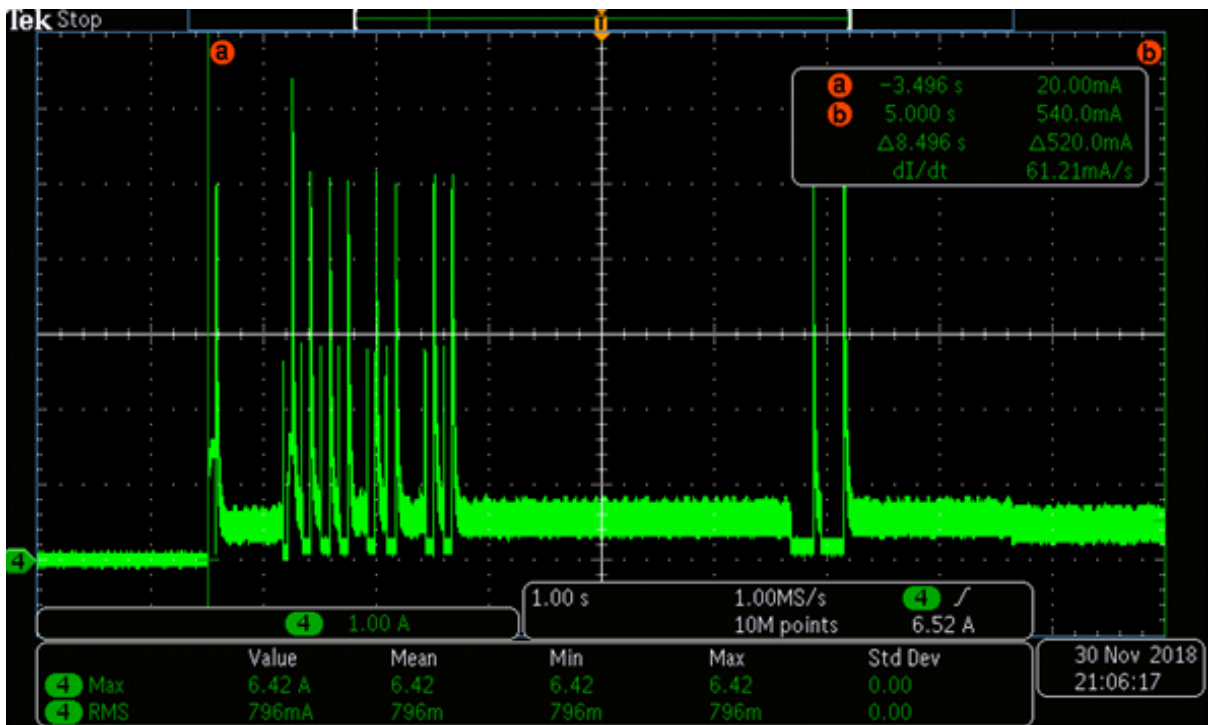

Pay Out (\$1.41 - 1 of each denomination)

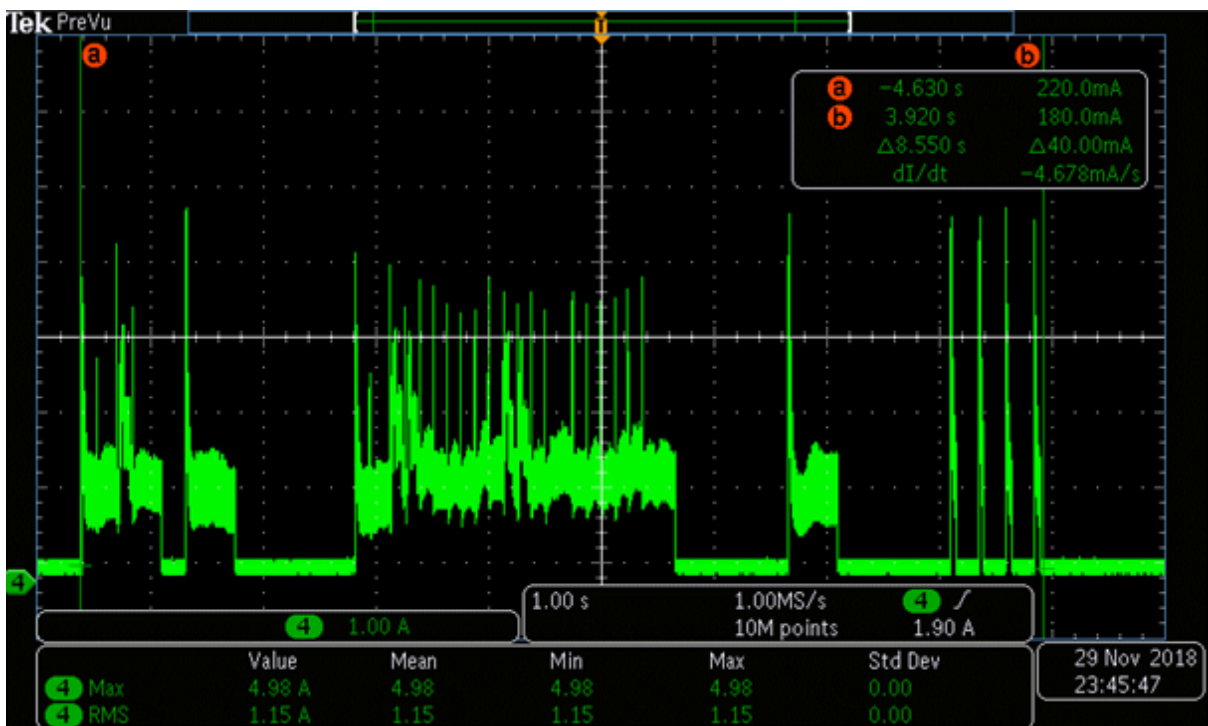

Peak: **4.98A**

RMS: **1.15A**

RMS measured across full 8.5 second pay out cycle.

Empty

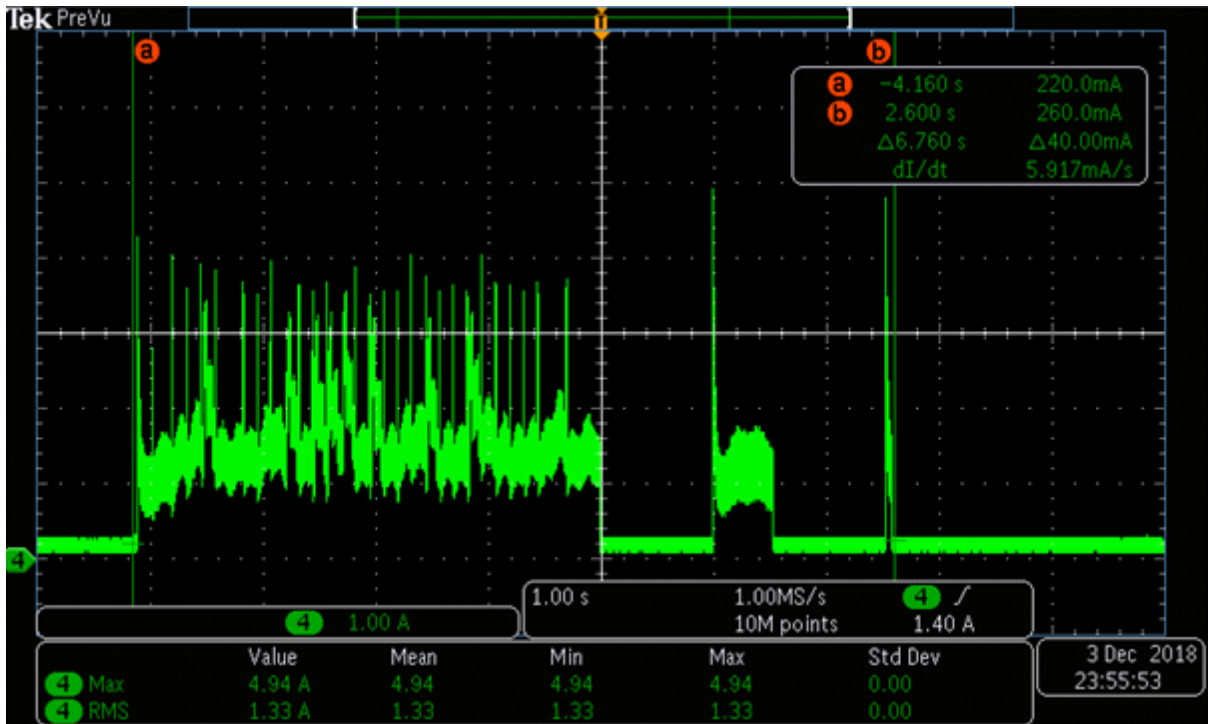

Peak: **4.94A**

RMS: **1.33A**

RMS measured across full 6.8 second pay out cycle.

Coin Feeder Coin Jam

Jamming the feeder disc motor **on start-up**

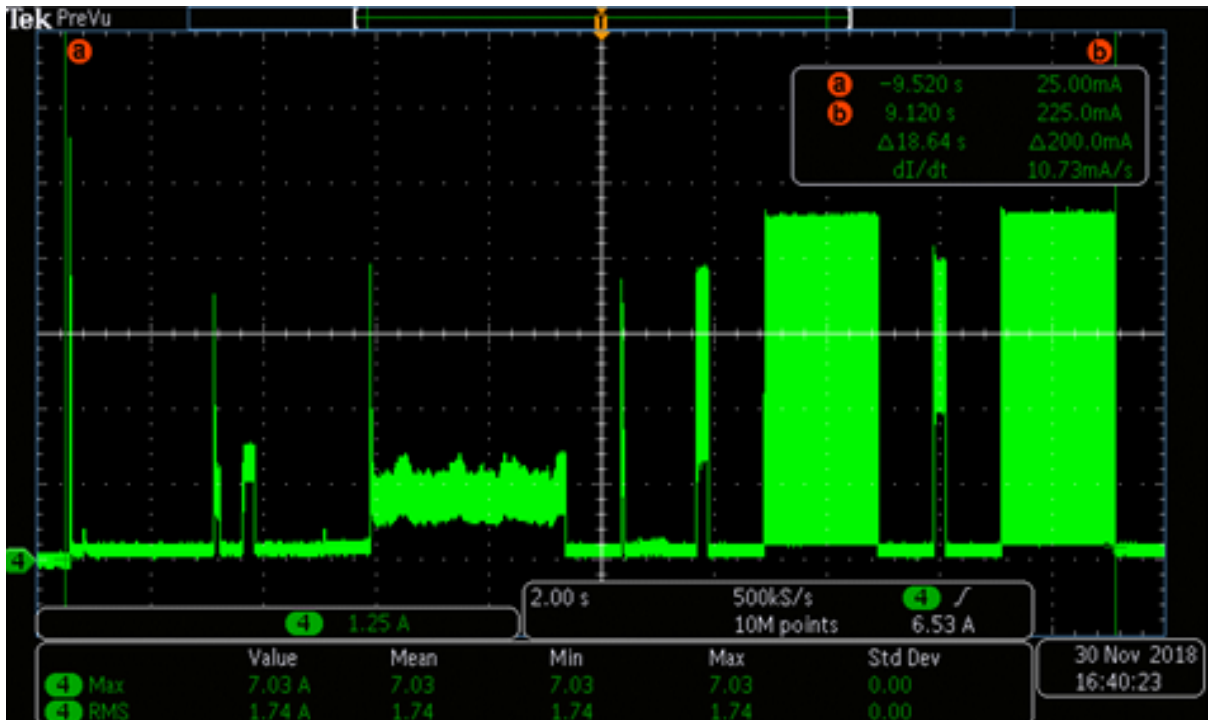

Peak: **7.01A (Inrush on start-up)**

RMS: **1.74A**

RMS measured across full 18.6 second pay out cycle.

The software attempts to un-jam the motor, operating for about 2 seconds. During this period, the current values are:



Peak: **5.83A**

RMS: **3.28A**

SMART Hopper Coin Jam

Jamming the hopper disc motor **on start-up**

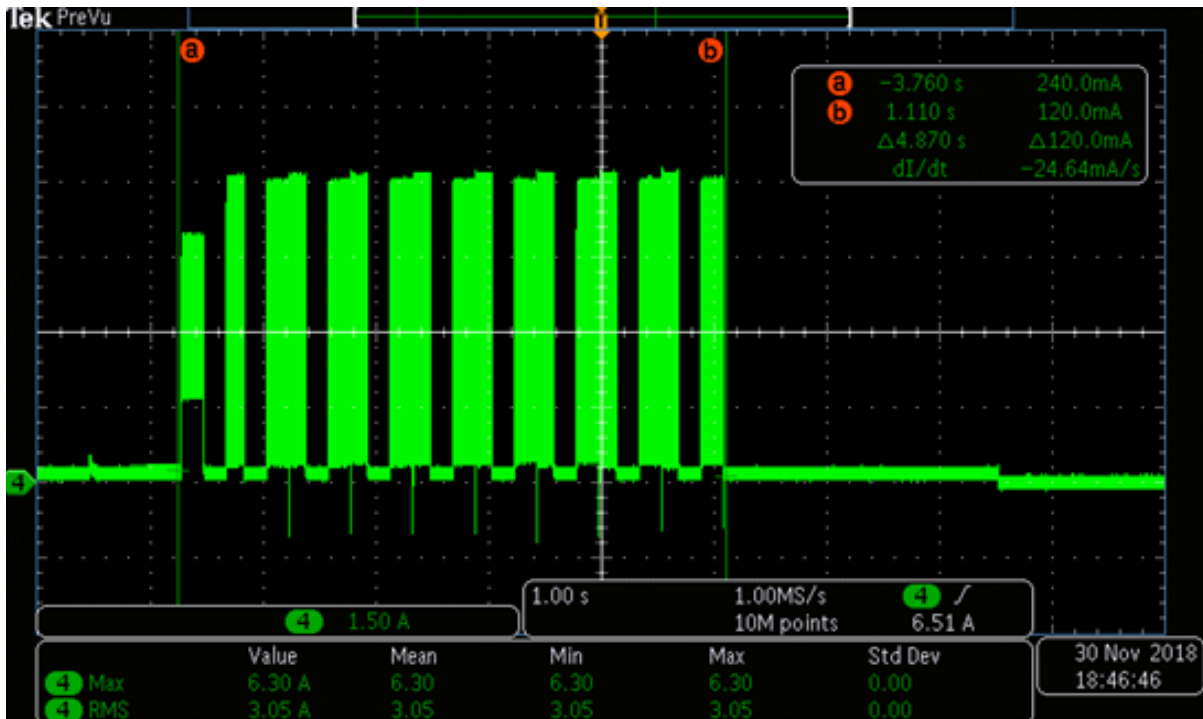

Zoomed In:

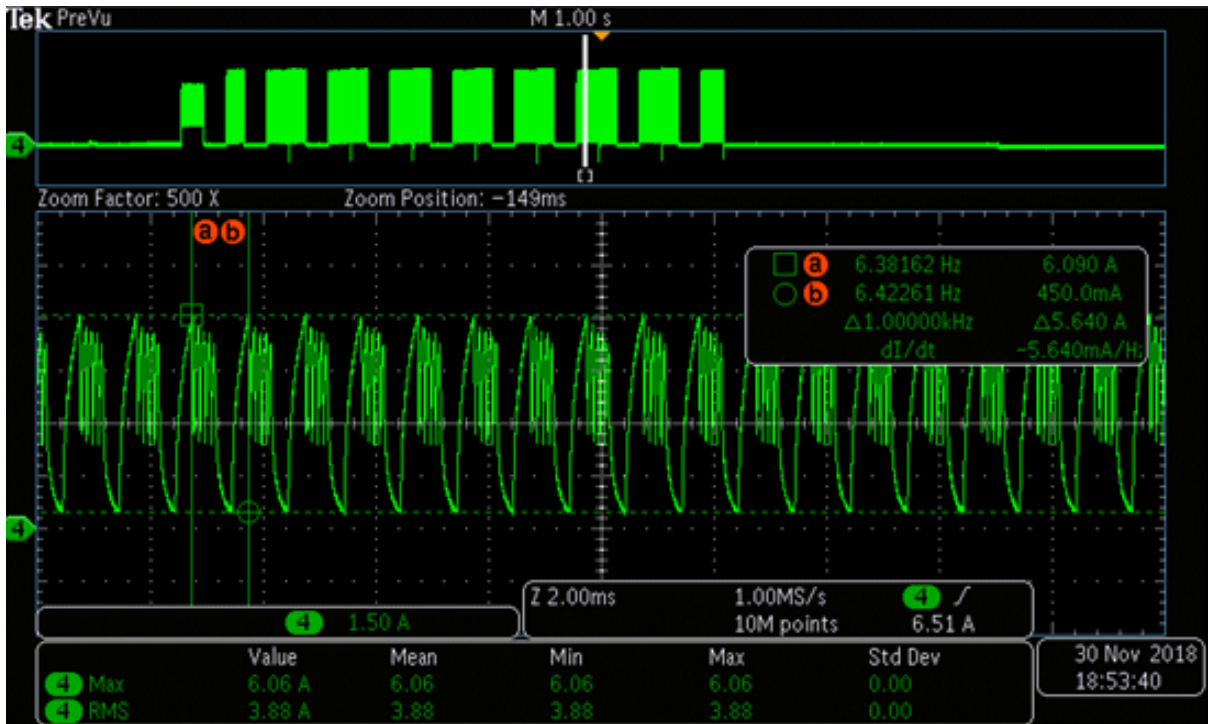

Peak: **6.30A (Inrush on start-up)**

RMS: **3.05A**

RMS measured across full 4.9 second pay out cycle.

Energy Profiles TWIN SMART Coin System

Idle

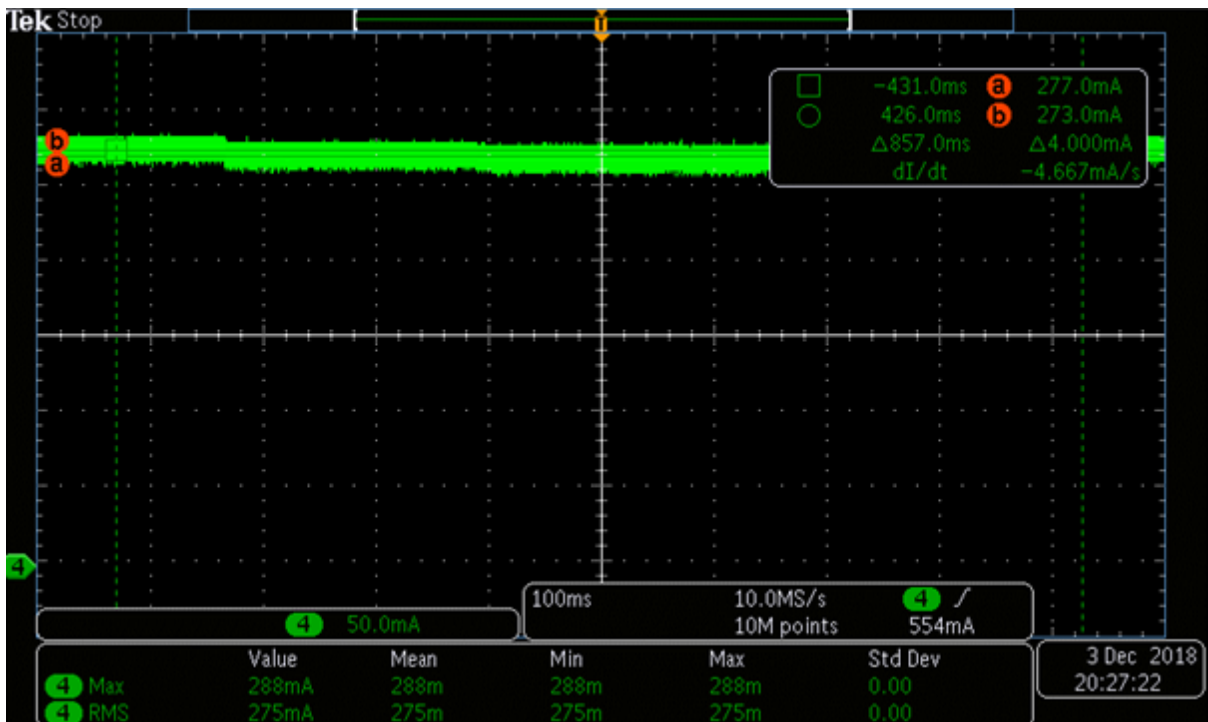

Peak: **288mA**

RMS: **275mA**

Power Up

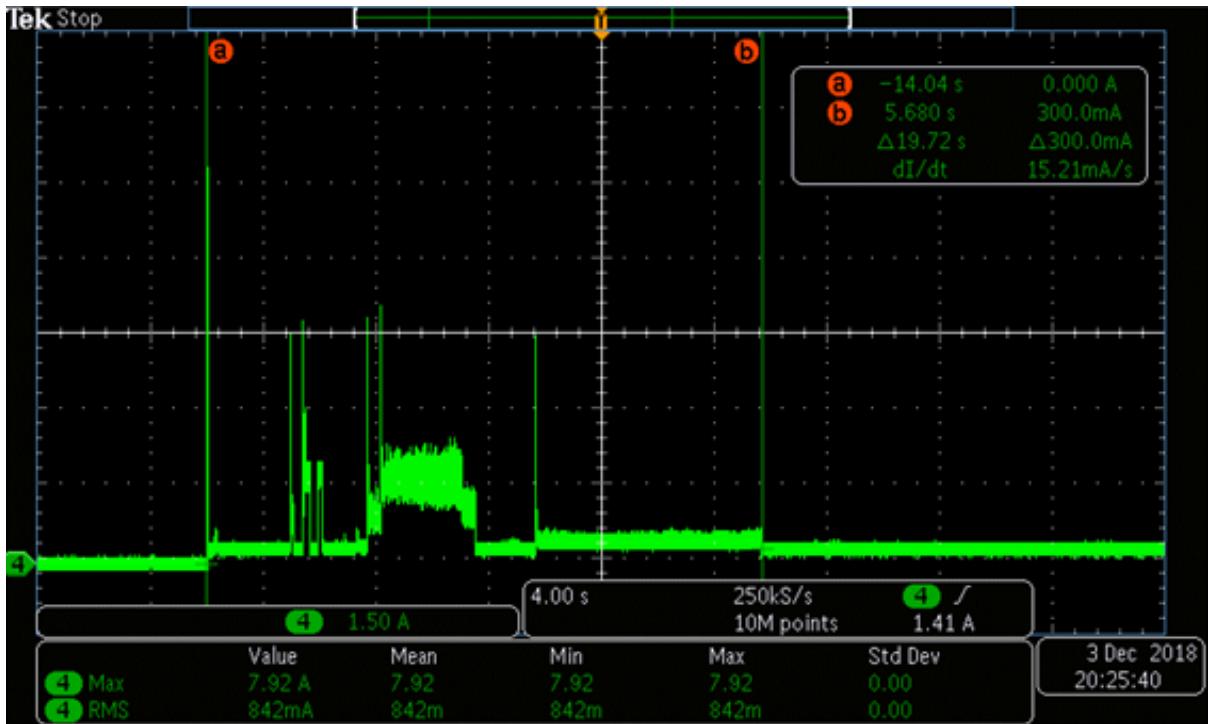

Pay In (€1.73)

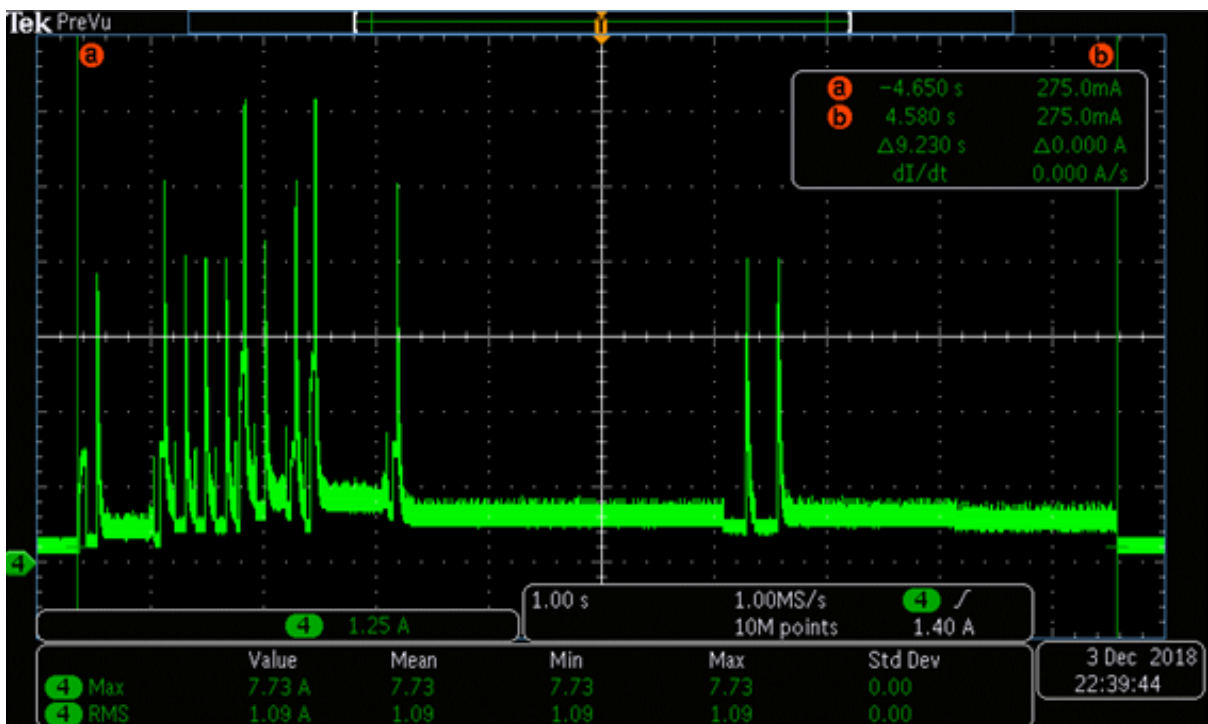

Peak: **7.73A**

RMS: **1.09A**

RMS measured across full 9.2 second pay in cycle.

Pay Out (€2.55)

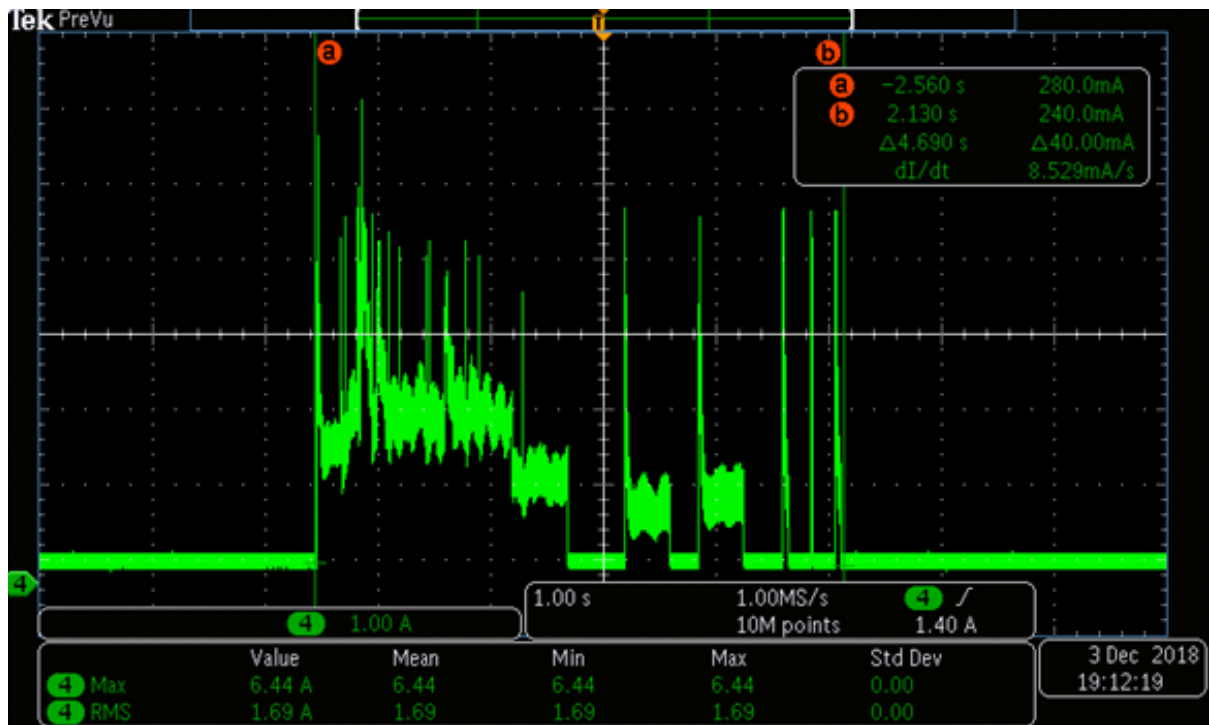

Peak: **6.44A**

RMS: **1.69A**

RMS measured across full 4.7 second pay out cycle.

Jam on Master Hopper and Slave Hopper at the same time

Jamming both hopper disc motors **on start-up**

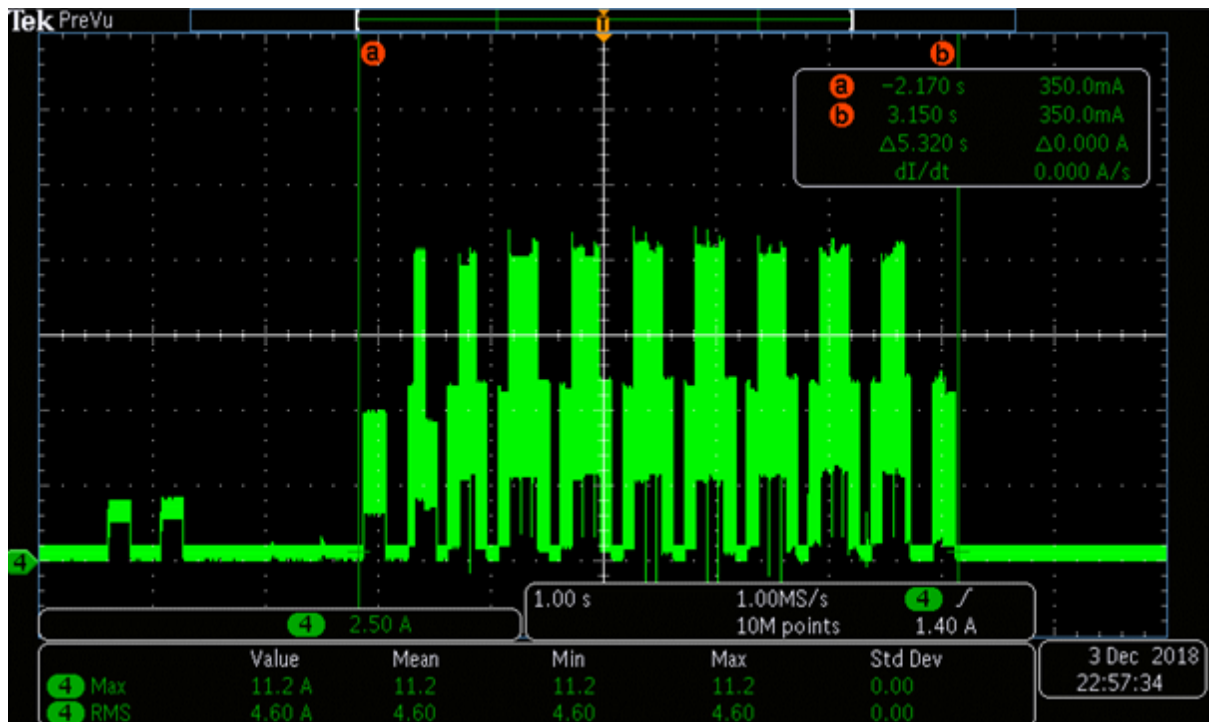

Peak: **11.2A**

RMS: **4.6A**

RMS measured across full 5.3 second anti-jam cycle.

Energy Profiles SMART Hopper

Idle

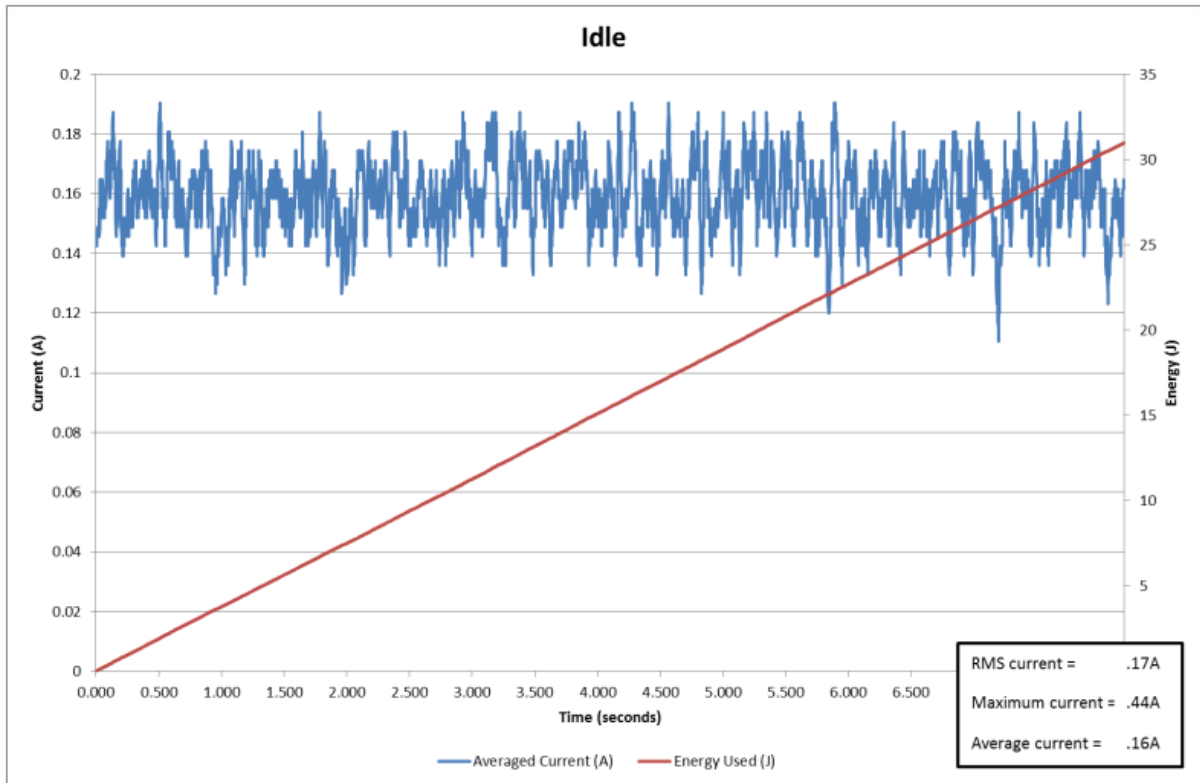

Power Up

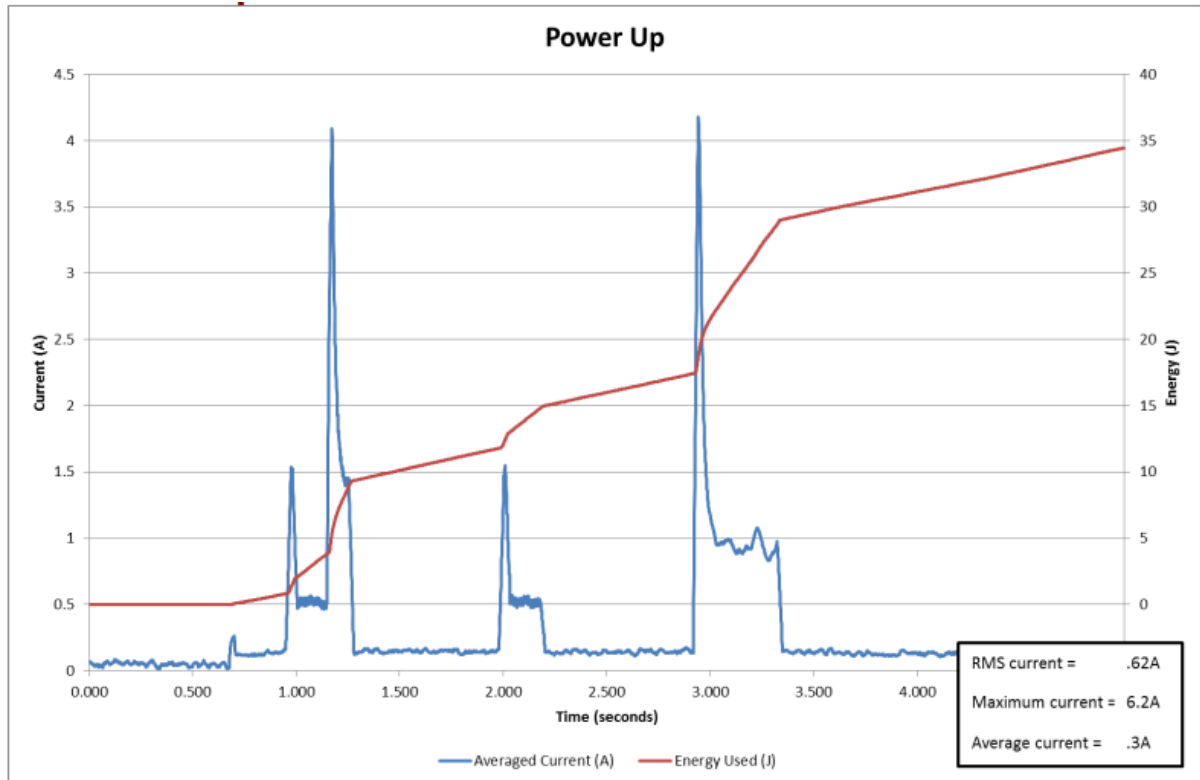

Pay Out

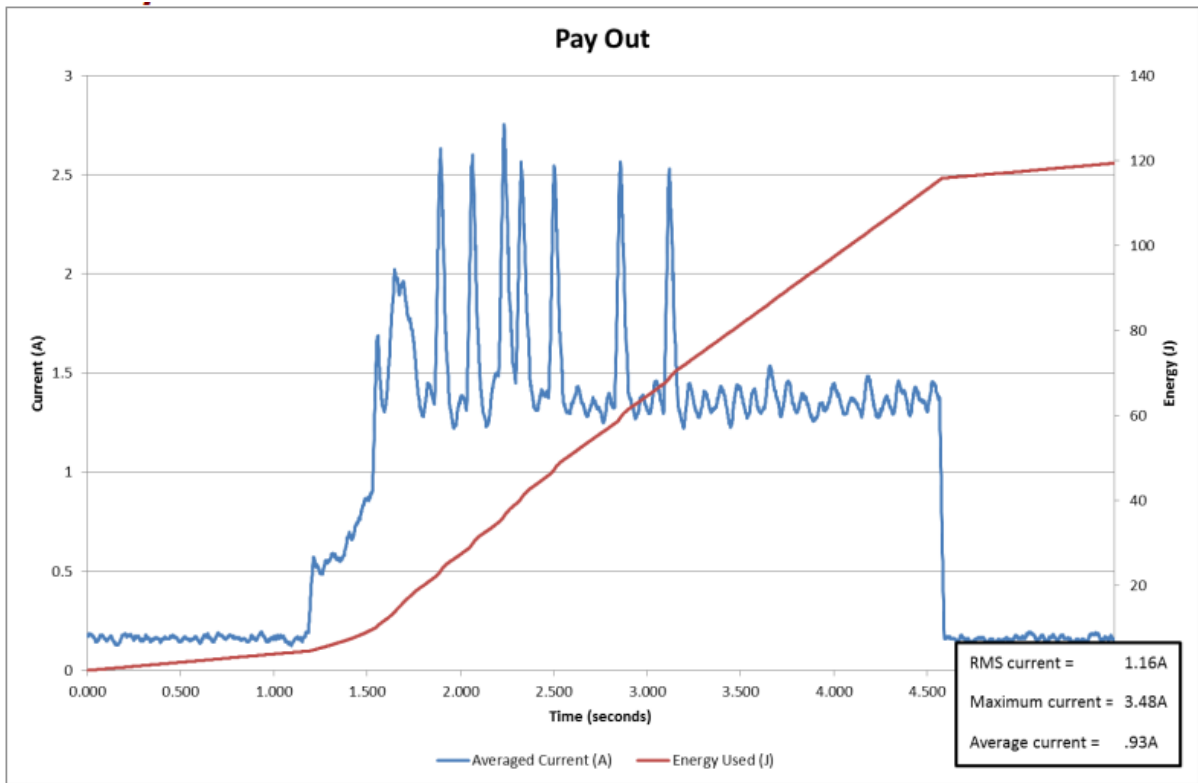

Empty

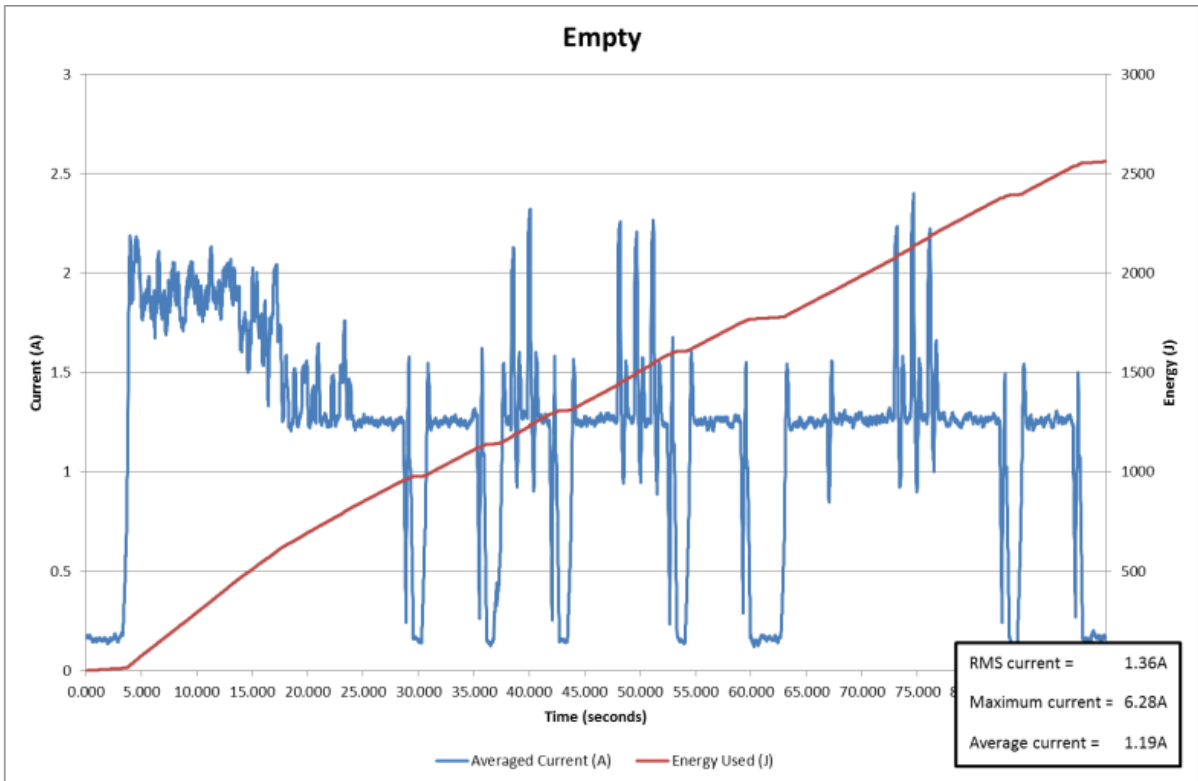

SMART Coin System Range Disclaimer and Safety Information

Contents

- [Disclaimer](#)
- [Product Safety Information](#)

Disclaimer

Innovative Technology:

- Is not responsible for any loss, harm, or damage caused by the installation and use of this product. This does not affect your local statutory rights. If in doubt, contact Innovative Technology for details of any changes.
- Has a policy of continual product improvement. As a result, the products supplied may vary from the specification described here.
- Does not accept liability for any errors or omissions contained within this document. Innovative Technology shall not incur any penalties arising out of the adherence to, interpretation of, or reliance on, this standard.



The contents of this manual set may be subject to change without prior notice.

Product Safety Information



Throughout this user manual, attention should be drawn to key safety points when using or maintaining the product.

These safety points will be highlighted in a box:



This is an example text.

This user manual and the information it contains is only applicable to the model stated on the front cover and must not be used with any other model.

 Danger!	IR and UV Radiation
 	<ul style="list-style-type: none">• Possible skin or eye damage due to presence of IR and UV radiation internally. Disconnect power before servicing• Use PPE measures• Follow safety precautions given in IEC 62471